

**NIKK**  
SWITCHES



RELIABLE SWITCH  
SOLUTIONS FOR THE  
**MEDICAL  
INDUSTRY**

## Switches for Medical Applications

NKK provides reliable switch solutions for the medical industry. As our population worldwide continues to grow, and age, the emphasis on improvements in medical technology and the evolution of medical equipment to support a healthy lifestyle are more important than ever. NKK products meet stringent medical guidelines for electrical equipment.

For high-performance, high-quality medical equipment to perform to its full potential, accurate and reliable ON/OFF control functionality is crucial. Each NKK part is backed by the advanced precision and experience gained as a leading company in the electromechanical industry for more than 65 years.

NKK is proud to provide not only trusted switch solutions, but also peace of mind for equipment manufacturers, healthcare professionals and patients alike.

NKK offers a variety of high quality, reliable products to meet the demands of the medical industry. All NKK products are designed and produced in-house and comply with the following standards and approvals:

- All products compliant
- RoHS and REACH
  - PFOS and PFOA Free
  - DMF Free
  - Ozone Depleting Chemical Free
  - Conflict Free Materials

Standards include:

UL, CSA, IEC, VDE, ISO



## NKK Products Used in Medical Electrical Equipment Meet IEC 60601-1 Edition 3.1

JP Series Pushbutton and JW Series Rocker switches are power supply switches that fulfill requirements of IEC 60601-1 Edition 3.1 Technical Standards for the safety and reliability of medical electrical equipment, published by the International Electrotechnical Commission (IEC).

The requirements of the power switch for the IEC 60601-1 Ed. 3.1 are specified in Chapter 7 regarding the indications, display, and text for ME equipment, and in Chapter 8 regarding protection against electrical hazards from ME equipment. The main requirements are listed below.

- \* 7.4 Control and meter display 7.4.1 Power switch “ON”/“OFF” position indication
- \* 8.11.1 Isolation from SUPPLY MAINS

- a) Isolate ME equipment’s circuits electrically from main power supply on all poles simultaneously.
- c) Creepage distance and clearance (point of contact = 3mm or greater) that meets the requirements detailed in IEC 61058-1 for carrying 4kV power voltage (for locations less than 2,000 feet above sea level).

NKK’s JP Series molded pushbuttons and JW Series molded rocker switches are power switches that fulfill these requirements.

This document presents power switches that are able to meet requirements of IEC 60601-1 Ed. 3.1 8.11.1, which is related to methods for isolation from the SUPPLY MAINS (commercial). Using these switches for any purpose other than isolation from the SUPPLY MAINS (commercial) may result in not fulfilling the standard requirements. For example, rocker switches with the “I - o” indication on it cannot be used as a secondary switch since “I - o” represents isolation from the SUPPLY MAINS (commercial).

The switches presented on this document have been VDE approved (VDE with IEC 61058-1, normal gap), to conform to IEC 61058-2000 (Switches for appliances, Part 1: General Appliances) which is the reference standard of IEC 60601-1 Ed. 3.1.

For switches with VDE approval that are certified as conforming to IEC 61058-1, it is usually not required to present detailed documents about the switch when taking the ME equipment certification exam. However, on rare occasions, detailed documents are requested as well as the disassembly and measurement of the switch itself. (If detailed documents are required, please contact the NKK Switches sales department.)

When equipping an NKK Switches product to ME equipment, contact our sales department to discuss the intended use of the product. Request the specifications document and use the product within its capacity and ability. When equipping a product, follow the designated method in the NKK Switches specification document and fulfill all requirements in IEC 60601-1 Ed. 3.1. In the event of a breakdown, follow the requirements in IEC 60601-1 Ed. 3.1 to safely resolve the issue.

This guide contains a collection of relevant information based on the laws, regulations, and standard specifications as of June 2018. NKK Switches has carefully checked the contents of this guide. However, NKK Switches cannot guarantee its accuracy and is not to be held responsible for any inaccuracies. We ask that you check the original documents establishing the laws, regulations and standards, and act in accordance with them. NKK Switches may also update the contents of this guide without notice.

## JPM Series

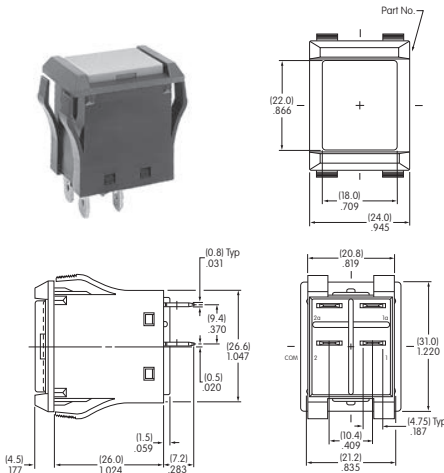

Part Number	Pole/Circuit	Rating	Actuator	Housing
JPM26B	DPST ON-OFF	10A @ 125/250V AC	*Cap	Barrier Flange
JPM26P	Lock type		Plunger	Flat Flange
*Cap Colors and Codes A Black B Ivory C Red H Gray				

Certifications	VDE	EN 61058 - 1 (CLASS II) 5A / 80A 250V ~ 10 (6) / 250V
	UL	TV Rating (120V): TV-5 UL File E44145
	C-UL	TV Rating (120V): TV-5 UL File E44145
	CSA	TV Rating (120V): TV-5 CSA File LR23535

- Switches are supplied without UL & VDE markings unless specified.
- UL recognized only when ordered with marking on the switch.
- VDE approved only when ordered with marking on the switch.
- The rated value of the switch may differ from the rated value of the certified standard.

Panel cutout: 21.2mm x 28.0mm (.835" x 1.102")	Panel thickness: 1.0mm ~ 4.0mm (.039" x .157")
--	--

Note: JPM series does not have ON/OFF indication symbols. However, it is available as a custom order.

## JPL Series

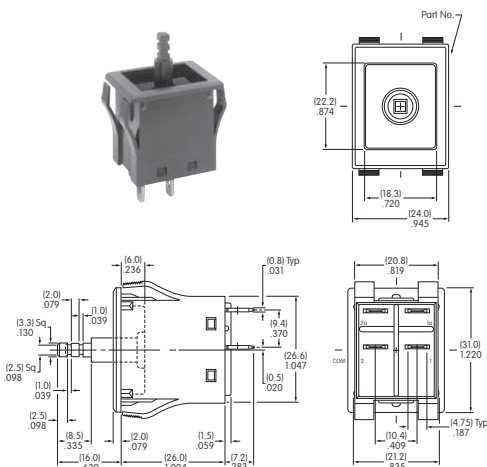

Part Number	Pole/Circuit	Rating	Actuator	Housing
JPL26B	DPST ON-OFF	16A @ 125/250V AC	*Cap	Barrier Flange
JPL26P	Lock type		Plunger	Flat Flange
*Cap Colors and Codes A Black B Ivory C Red H Gray				

Certifications	VDE	EN 61058 - 1 (CLASS II) 8A / 128A 250V ~ 16 (8) 250V
	UL	TV Rating (120V): TV-8 UL File E44145
	C-UL	TV Rating (120V): TV-8 UL File E44145

- Switches are supplied without UL & VDE markings unless specified.
- UL recognized only when ordered with marking on the switch.
- VDE approved only when ordered with marking on the switch.
- The rated value of the switch may differ from the rated value of the certified standard.

Panel cutout: 21.2mm x 28.0mm (.835" x 1.102")	Panel thickness: 1.0mm ~ 4.0mm (.039" x .157")
--	--

Note: JPL series does not have ON/OFF indication symbols. To fulfill IEC 60601-1 Ed. 3.1, 7.4.1, JPL would need to combine with an external actuator with the symbols.

## JWS Series

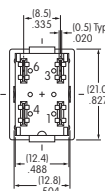
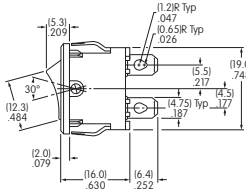
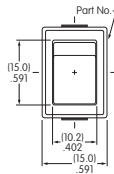

Part Number	Pole/Circuit/Rating	Cap Color Code	Housing Code	On and Off Inscription		
JWS21RAA-J2D	DPST ON-OFF 10A @ 125V AC 10A @ 250V AC	Black	A	Black	A	Horizontal   ○
JWS21RBA-J2D		Ivory	B	Black	A	
JWS21RBB-J2D		Ivory	B	Ivory	B	Vertical - ○
JWS21RAA-J8L		Black	A	Black	A	
JWS21RBA-J8L		Ivory	B	Black	A	
JWS21RBB-J8L		Ivory	B	Ivory	B	

Certifications	VDE	EN 61058-1 (CLASS II) 5A / 80A 250V ~ 10 (6) / 250V ~
UL	UL 61058-1 Current capacity: 6A 125V AC, 6A 250V AC UL File E44145	
C-UL	CSA C 22.2 No.55 equivalent current capacity: 6A 125V AC, 6A 250V AC UL File E44145	

- Approvals are displayed on the product.
- Rated value of the switch differs from the rated value of the certified standard.

Panel cutout: 12.9mm x 19.2mm (.508" x .756")	Panel thickness no barrier: 0.75mm ~ 2.0mm (.030" ~ .079") Panel thickness with barrier: 0.6mm ~ 1.5mm (.024" ~ .059")
---	---

Part numbers listed above are custom numbers. Contact NKK Switches to order.

## JWM Series

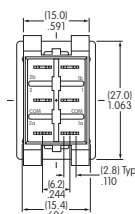
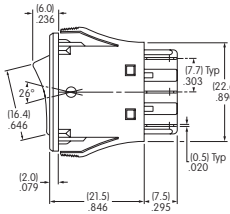
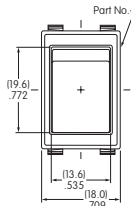

Part Number	Pole/Circuit/Rating	Cap Color Code	Housing Code	On and Off Inscription		
JWM21RA1A	DPST ON-OFF 10A @ 125V AC 10A @ 250V AC	Black	A	Black	A	○
JWM21RB1A		Ivory	B	Black	A	
JWM21RB1B		Ivory	B	Ivory	B	
JWM21RB1H		Ivory	B	Gray	H	
JWM21RH1A		Gray	H	Black	A	
JWM21RH1H		Gray	H	Gray	H	

Certifications	VDE	EN 61058-1 (CLASS II) 5A / 80A 250V ~ 10 (6) / 250V ~
UL	UL 1054 Current capacity: 10A 250V AC TV rating (120V): TV-5 UL File E44145	
CSA	CSA C 22.2 No.55 Current capacity: 10A 250V AC TV rating (120V): TV-5 CSA File LR23535	

- Approvals are displayed on the product.
- Rated value of the switch differs from the rated value of the certified standard.

Panel cutout: 15.4mm x 24.0mm (.606" x .945")	Panel thickness no barrier: 1.0mm ~ 4.0mm (.039" ~ .157") Panel thickness with barrier: 0.6mm ~ 3.2mm (.024" ~ .126")
---	--

## JWL Series

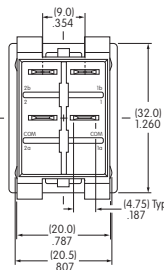
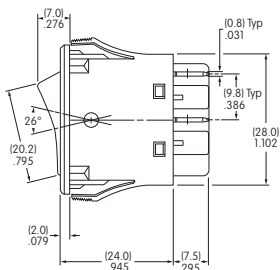
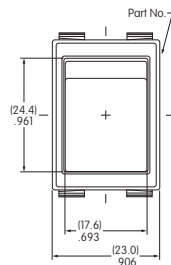



Part Number	Pole/Circuit/Rating	Cap Color Code	Housing Code	On and Off Inscription		
JWL21RA1A	DPST ON-OFF 16A @ 125V AC 16A @ 250V AC	Black	A	Black	A	○
JWL21RB1A		Ivory	B	Black	A	
JWL21RB1B		Ivory	B	Ivory	B	
JWL21RB1H		Ivory	B	Gray	H	
JWL21RH1A		Gray	H	Black	A	
JWL21RH1H		Gray	H	Gray	H	

Certifications	VDE	EN 61058-1 (CLASS II) 8A / 128A 250V ~ 16 (8) / 250V ~
UL	UL 1054 current capacity: 16A 250V AC TV rating (120V): TV-8 UL File E44145	
CSA	CSA C 22.2 No.55 Current capacity: 16A 250V AC TV rating (120V): TV-8 CSA File LR23535	



- Approvals are displayed on the product.
- Rated value of the switch differs from the rated value of the certified standard.



Panel cutout: 20.5mm x 29.5mm (.807" x 1.161")	Panel thickness no barrier: 1.0mm ~ 4.0mm (.039" ~ .157") Panel thickness with barrier: 0.6mm ~ 3.2mm (.024" ~ .126")
--	--

## NKK Product Overview

<p>Images are for reference only. For complete information, see NKK Switches full line product catalog.</p>	<p><b>Electrical Rating</b></p>	<p><b>IP Rating</b></p>	<p><b>Size</b></p>	<p><b>Product Series</b></p>
<p><b>SmartSwitch® Product Line with Programmable Display</b></p>  <p>Programmable, illuminated display provides clear, crisp visibility in various medical treatment settings. Programmable flexibility for a multitude of options.</p>	<p>Pushbutton: 100mA @ 12V DC  Rocker: 3VA max DC</p>	<p><b>IP64</b>  (OLED Rocker)</p>	<p>Compact to Standard</p>	<p>SmartSwitch</p>
<p><b>Pushbuttons – Illuminated and Nonilluminated</b></p>  <p>Crisp actuation and brilliant LED illumination options available in an array of colors. Industry-leading color matching technology combined with high reliability well suited for many medical applications.</p>	<p>Logic Level to 16A</p>	<p><b>IP65</b> <b>IP67</b> available; environmentally sealed option</p>	<p>Subminiature to Standard</p>	<p>AB, BB, EB, FB, FP01, GB, GB2, G3B, HB, HB2, JP, KB, KP, LB, LP01, M2B, MB2000, MB2400, NP01, SB, SCB, UB, UB2, WB, YB, YB2</p>
<p><b>Toggles – Illuminated and Nonilluminated</b></p>  <p>High quality and dependability. Fully illuminated and LED-tipped illuminated versions available in a range of colors. Designed to perform and withstand extreme environments for critical applications.</p>	<p>Logic Level to 50A</p>	<p><b>IP65</b> <b>IP67</b> available; environmentally sealed option</p>	<p>Subminiature to Standard</p>	<p>A, B, G, G3T, M, M2100, M2T, P, S, TL, WT</p>

NKK Product Overview

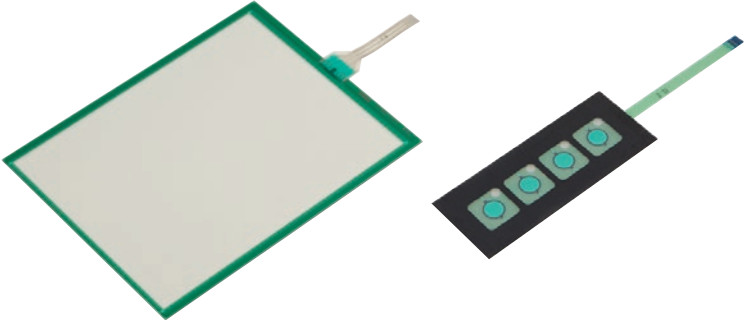
<p>Images are for reference only. For complete information, see NKK Switches full line product catalog.</p>	<p>Electrical Rating</p>	<p>IP Rating</p>	<p>Size</p>	<p>Product Series</p>
<p><b>Rockers – Illuminated and Nonilluminated</b></p>  <p>Power level, IP-rated, process-sealed versions available in various mounting and termination styles to accommodate a wide range of medical applications. Brilliant LED illumination options available to customize.</p>	<p>Logic Level to 30A</p>	<p><b>IP65</b> <b>IP67</b> available; environmentally sealed option</p>	<p>Subminiature to Standard</p>	<p>A, CW, G, GW, JW, JWS, LW, M, M2100, M2T, MLW, P, SW, WR</p>
<p><b>Slides – Illuminated and Nonilluminated</b></p>  <p>Award-winning STC contact mechanism with benefits available in conventional mechanisms: smoother, positive detent actuation, increased contact stability and unparalleled logic-level reliability. SMT options.</p>	<p>Logic Level to 6A</p>		<p>Subminiature to Miniature</p>	<p>AS, CS, FS, JS, MS, SM, SS, SS3</p>
<p><b>Tactiles – Illuminated and Nonilluminated</b></p>  <p>Specially process-sealed construction prevents contact contamination and allows for automated wave soldering and cleaning. Crisp tactile feedback to positively indicate circuit transfer. SMT options.</p>	<p>Logic Level to 125mA @ 24V DC</p>		<p>Subminiature to Miniature</p>	<p>CB, CB3, HP02, HP03, JB, JF, JL</p>

<p>Images are for reference only. For complete information, see NKK Switches full line product catalog.</p>	<p><b>Electrical Rating</b></p>	<p><b>IP Rating</b></p>	<p><b>Size</b></p>	<p><b>Product Series</b></p>
<p><b>Rotaries</b></p>  <p>A comprehensive line of rotaries meets a variety of applications, including 8 or 10mm DIP rotaries, half-inch diameter process-sealed models, power level devices. A variety of knobs and caps available.</p>	<p>Logic Level to 30A</p>	<p><b>IP67</b> Options Available</p>	<p>Ultra-miniature to Standard</p>	<p>FR01, FR02, HS, MR, MRB, ND, ND3, PS, TS</p>
<p><b>Touch Screens and Membranes</b></p>  <p>Multi-touch technology resistive touch screens well suited for gloved-hand medical environments. Membrane switch keypads with crisp, tactile feel to ensure clear feedback in critical applications.</p>	<p>Touch Screens: 5-wire resistive 5.5V DC 4-Wire Resistive &amp; Digital 1mA @ 5V DC</p> <p>Membranes: 20mA @ 24V DC</p>		<p>Touch Screens: 5.7" to 19"</p> <p>Membranes: 4-, 12- and 16-Key Illuminated or Nonilluminated</p>	<p>FT, TP01 (Touch Screens); FM (Membrane)</p>
<p><b>Keylocks and Tilt Switches</b></p>  <p>Five types of keylocks for a range of security needs, from antistatic process-sealed subminiature to high-security standard size options. Mercury-free tilt switches constructed with metallic ball contacts or photo interrupter.</p>	<p>Keylocks: Logic Level to 3A</p> <p>Tilt: 0.1A @ 12V DC; 5V Photo Interrupter</p>		<p>Keylocks: Subminiature to Standard</p> <p>Tilt: Miniature, Subminiature</p>	<p>Keylocks: CK, SK</p> <p>Tilt: DSA, DSB</p>

## Medical Application Examples

### X-RAY / MEDICAL IMAGING / ULTRASOUND



JP PUSHBUTTON



UB PUSHBUTTON



UB2 PUSHBUTTON



JW ROCKER



YB PUSHBUTTON

### TREATMENT TOOLS / MACHINES



CWSB ROCKER



SMARTSWITCH



LP01 PUSHBUTTON



CK KEYLOCK



JW ROCKER



JP PUSHBUTTON

### PATIENT MONITORS



LB PUSHBUTTON

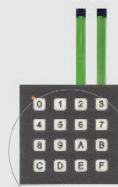

FM MEMBRANE



YB2 PUSHBUTTON

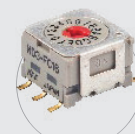

ND3 ROTARY

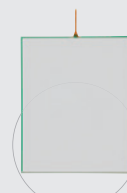

TP01 TOUCH SCREEN

**MEASURING EQUIPMENT / METERS**



LP01 PUSHBUTTON



YB2 PUSHBUTTON



MRK ROTARY



JW ROCKER

**DENTAL EQUIPMENT / CHAIRS**



JP PUSHBUTTON



M TOGGLE



LW ROCKER



LB PUSHBUTTON



CK KEYLOCK

**3D CAD Models**

Our website, [www.nkkswitches.com](http://www.nkkswitches.com), features 600,000+ downloadable CAD models in over 150 file formats.

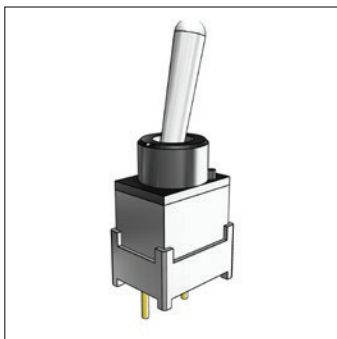

## Custom Switches and Value-Added Capabilities

NKK offers a full suite of customizable solutions and value-added services. Our expert team of engineers can assist in designing the perfect solution.

### CUSTOM SWITCHES Customization to Caps | Actuators | Terminals | Housing



### PRINTING Screen Printing | Pad Printing | Laser Etching

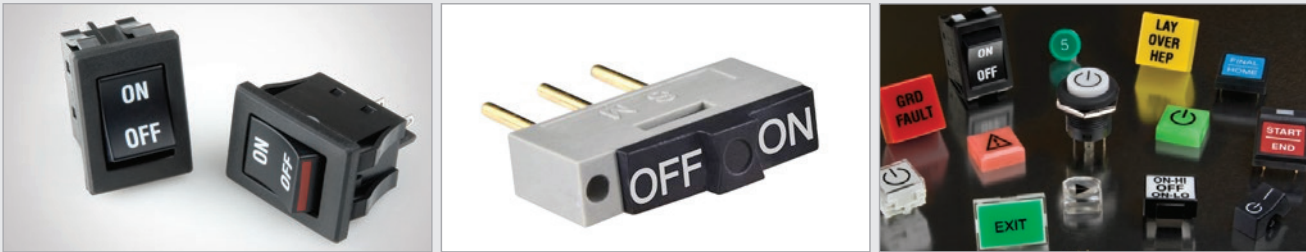

### ASSEMBLY Electronic Assembly | Mechanical Assembly | Electromechanical Assembly



### ADDED VALUE Machining of Parts | Sheet Metal Work | Coatings | Engineering Services



# A Worldwide Distribution of Sales and Services



---

## **NKK SWITCHES OF AMERICA, INC.**

7850 E. Gelding Drive, Scottsdale, AZ 85260 U.S.A. Tel: 1 480 991 0942 Fax: 1 480 998 1435  
www.nkkswitches.com Email: customerservice@nkkswitches.com

### **Global Offices:**

#### **NKK Corporate Headquarters**

#### **NKK SWITCHES CO., LTD.**

715-1 Unane, Takatsu-ku, Kawasaki-shi, 213-8553, Japan

Tel: 81 44 813 8001 Fax: 81 44 813 8031 www.nkkswitches.co.jp E-mail: nkkswitches@nkkswitches.co.jp

#### **Europe**

#### **NKK SWITCHES CO., LTD. European Liaison Office**

Mergenthalerallee 10-12, 65760 Eschborn, Germany Tel: 49 61 96 400 187 (English) / 49 61 96 400 189 (Deutsch)  
www.nkkswitches.eu / www.nkkswitches.de Email: contact@nkkswitches.eu

#### **Asia**

#### **NKK SWITCHES HONG KONG CO., LTD.**

Rm. 601, Fook Yip Building, 53-57 Kwai Fung Crescent, Kwai Chung, N.T., Hong Kong

Tel: 852 2366 6634 Fax: 852 2366 6803 www.nkkswitches.com.hk Email: info@nkkswitches.com.hk

#### **China**

#### **NKK SWITCHES CHINA CO., LTD.**

Rm. 702, Center Tower, Huaning Plaza, 300 Xuanhua Rd., Changning, Shanghai China

Tel: 86 21 6249 6574 Fax: 86 21 6248 3375 www.nkkswitches.com.cn Email: info@nkkswitches.com.cn

The logo for NKK Switches features the word "NKK" in a bold, sans-serif font. The "N" and "K" are white, while the second "K" is red. Below "NKK" is the word "SWITCHES" in a smaller, white, spaced-out sans-serif font.

**NKK**  
SWITCHES

**NKK SWITCHES OF AMERICA, INC.**

7850 East Gelding Drive  
Scottsdale, Arizona 85260  
Phone 480.991.0942 / Toll-Free 1.877.228.9655  
[www.nkkswitches.com](http://www.nkkswitches.com)