

## Contents

	Page
Description of the Han-Modular® system .....	<b>06.03</b>
Summary Han-Modular® .....	<b>06.04</b>
Han-Modular® Compact .....	<b>06.08</b>
Han-Modular® Twin .....	<b>06.12</b>
Han-Modular® Hinged frames .....	<b>06.14</b>
Han-Modular® Docking frames .....	<b>06.16</b>
Han-Modular® ECO .....	<b>06.20</b>
Han® 200 A Axial module .....	<b>06.24</b>
Han® 200 A Crimp module .....	<b>06.26</b>
Han® 100 A Axial module .....	<b>06.28</b>
Han® 100 A Crimp module .....	<b>06.30</b>
Han® 100 A Single module .....	<b>06.32</b>
Han® 70 A Axial module .....	<b>06.34</b>
Han® 70 A Crimp module .....	<b>06.36</b>
Han® 40 A Axial module .....	<b>06.38</b>
Han® 40 A Crimp module .....	<b>06.40</b>
Han® C Axial module .....	<b>06.42</b>
Han® C module .....	<b>06.44</b>
Han® CC Protected module .....	<b>06.46</b>
Han® CD module .....	<b>06.48</b>
Han E® module .....	<b>06.50</b>
Han® EE module .....	<b>06.52</b>
Han® EE Quick Lock module .....	<b>06.54</b>
Han E® Protected module .....	<b>06.56</b>
Han® EEE module .....	<b>06.58</b>
Han® ES module .....	<b>06.60</b>
Han® HV module .....	<b>06.62</b>
Han DD® module .....	<b>06.66</b>

Han DD® Quick Lock module .....	<b>06.68</b>
Han® DDD module .....	<b>06.70</b>
Han® High Density module .....	<b>06.72</b>
Han® D-Sub module .....	<b>06.74</b>
Han® USB module .....	<b>06.76</b>
Han® FireWire module .....	<b>06.78</b>
Han® RJ45 module .....	<b>06.80</b>
Han® GigaBit module .....	<b>06.86</b>
Han-Quintax® module .....	<b>06.90</b>
Han® Coax module .....	<b>06.92</b>
Han® Multi module according to DIN 41 626 .....	<b>06.94</b>
Han® Multi module according to D-Sub .....	<b>06.96</b>
Han® Multi module .....	<b>06.98</b>
Han® Pneumatic module .....	<b>06.100</b>
Han® SC module .....	<b>06.104</b>
Han-Elisa® .....	<b>06.106</b>
Han-Elisa® Pt100 Modul .....	<b>06.108</b>
Han-Elisa® Output module .....	<b>06.110</b>
Han-Elisa® ID module .....	<b>06.112</b>
Han-Modular® Accessories .....	<b>06.114</b>

## Description of the Han-Modular® system

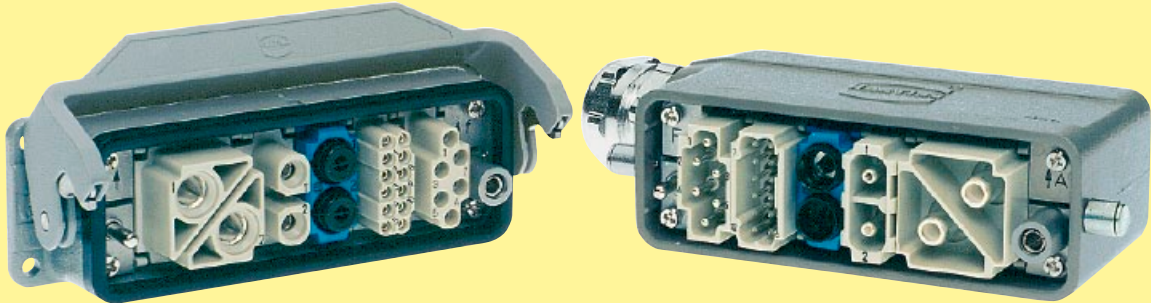

The Han-Modular® series is a new system of inserts designed to meet the specific requirements of individual customers. In close cooperation with potential users a range of modular inserts have been developed allowing the simple assembly of custom designed complete connectors which meet the diverse requirements encountered by designers today.

Han-Modular® is a logical development of the Han-Com® series which already offers the combination of power and signal circuits in one connector.

The individual modules of this series now allow the integration of electrical, optical and gaseous signal and power connections in one connector assembly.

The pneumatic contacts are also suitable for the connection of liquid media. However it must be stated that a combination of electrical and liquid connections in one connector is not allowed according to VDE regulations.

The individual contacts used in this system are all from existing well proven ranges and it is possible to use combinations of 1 to 12 modules depending on the size of the hoods and housings chosen.

The basic modules snap into a mounting frame and can be exchanged separately at any time.

### Advantages:

- Custom designs can be simply assembled
- Optimum solutions can be reached
- Stock can be minimized

### Assembly details

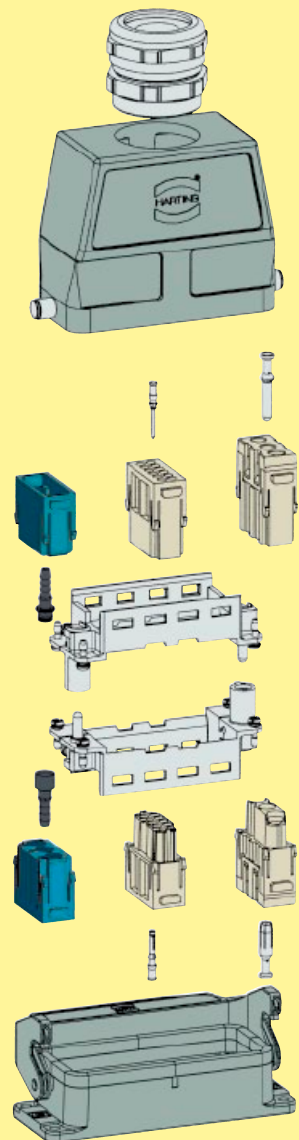

## Han-Modular® Compact

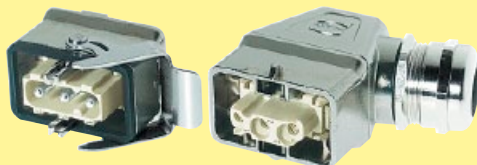

Page 06.08

## Han-Modular® Twin



Page 06.12

## Han-Modular® Hinged frames in Han® B hoods and housings

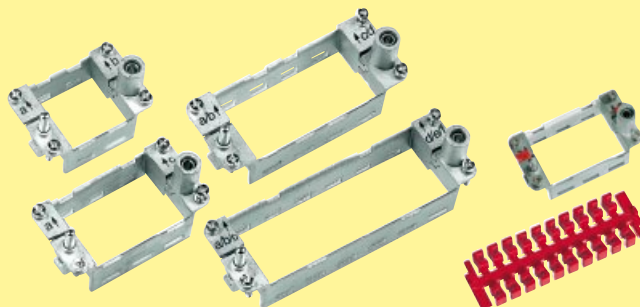

Page 06.14

## Han-Modular® Docking frame

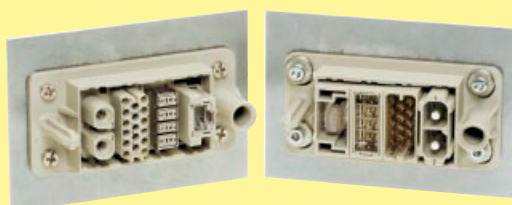









Page 06.16

## Han-Modular® ECO











Page 06.20





Series	Han® 200 A Axial module	Han® 200 A Crimp module	Han® 100 A Axial module	Han® 100 A Crimp module
Number of contacts	1	1	2	2
Modules	Axial screw terminal 	Crimp terminal 	Axial screw terminal 	Crimp terminal 
Rated current	200 A	200 A	100 A	100 A
Rated voltage	1000 V	1000 / 1000 V	1000 V	1000 V
Wire gauge	25 ... 70 mm <sup>2</sup>	25 ... 70 mm <sup>2</sup>	10 ... 38 mm <sup>2</sup>	10 ... 35 mm <sup>2</sup>
Page	06.24	06.26	06.28	06.30

Series	Han® 100 A Single module	Han® 70 A Axial module	Han® 70 A Crimp module	Han® 40 A Axial module
Number of contacts	1	2	2	2
Modules	Crimp terminal 	Axial screw terminal 	Crimp terminal 	Axial screw terminal 
Rated current	100 A	70 A	70 A	40 A
Rated voltage	830 V	1000 V	1000 V	1000 V
Wire gauge	10 ... 35 mm <sup>2</sup>	6 ... 22 mm <sup>2</sup>	10 ... 25 mm <sup>2</sup>	2.5 ... 10 mm <sup>2</sup>
Page	06.32	06.34	06.36	06.38



Han  
Modular



Series	Han® 40 A Crimp module	Han® C Axial module	Han® C module	Han® CC Protected module
Number of contacts	2	3	3	4
Modules	Crimp terminal 	Axial screw terminal 	Crimp terminal 	Crimp terminal 
Rated current	40 A	40 A	40 A	40 A
Rated voltage	1000 V	690 V	400 / 690 V	830 V
Wire gauge	1.5 ... 10 mm <sup>2</sup>	2.5 ... 10 mm <sup>2</sup>	1.5 ... 10 mm <sup>2</sup>	1.5 ... 6 mm <sup>2</sup>
Page	06.40	06.42	06.44	06.46



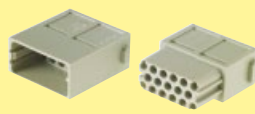

Series	Han® CD module	Han E® module	Han® EE module	Han® EE Quick Lock module
Number of contacts	3 / 4	6	8	8
Modules	Crimp terminal 	Crimp terminal 	Crimp terminal 	Quick Lock terminal 
Rated current	40 A / 10 A	16 A	16 A	16 A
Rated voltage	830 V / 830 V	500 V	400 V	400 V
Wire gauge	1.5 ... 6 mm <sup>2</sup> / 0.14 ... 2.5 mm <sup>2</sup>	0.14 ... 4 mm <sup>2</sup>	0.14 ... 4 mm <sup>2</sup>	0.5 ... 2.5 mm <sup>2</sup>
Page	06.48	06.50	06.52	06.54



















Series	Han E® Protected module	Han® EEE module	Han® ES module	Han® HV module
Number of contacts	6	20	5	2
Modules	Crimp terminal 	Crimp terminal 	Cage-clamp terminal 	Crimp terminal 
Rated current	16 A	16 A	16 A	16 A
Rated voltage	830 V	500 V	400 V	2900 / 5000 V
Wire gauge	0.14 ... 4 mm <sup>2</sup>	0.14 ... 4 mm <sup>2</sup>	0.14 ... 2.5 mm <sup>2</sup>	0.5 ... 4 mm <sup>2</sup>
Page	06.56	06.58	06.60	06.62

Han Modular

Series	Han® HV module	Han DD® module	Han DD® Quick Lock module	Han® DDD module
Number of contacts	2	12	12	17
Modules	Crimp terminal 	Crimp terminal 	Quick Lock terminal 	Crimp terminal 
Rated current	40 A	10 A	10 A	10 A
Rated voltage	2900 / 5000 V	250 V	250 V	160 V
Wire gauge	1.5 ... 10 mm <sup>2</sup>	0.14 ... 2.5 mm <sup>2</sup>	0.25 ... 1.5 mm <sup>2</sup>	0.14 ... 2.5 mm <sup>2</sup>
Page	06.64	06.66	06.68	06.70

Series	Han® High Density module	Han® D-Sub module		
Number of contacts	25	9		
Modules	Crimp terminal 	Crimp terminal 		
Rated current	4 A	5 A		
Rated voltage	50 V	50 V		
Wire gauge	0.08 ... 0.52 mm <sup>2</sup>	0.08 ... 0.52 mm <sup>2</sup>		
Page	06.72	06.74		

Series	Han® USB module	Han® FireWire module	Han® RJ45 module	Han® GigaBit module
Number of contacts	4	6	8	8
Modules	USB 2.0 	IEEE 1394 	Ethernet Cat. 6 	Ethernet Cat. 6 <sub>A</sub> 
Page	06.76	06.78	06.80	06.86

Series	Han-Quintax® module			
Number of contacts	2			
Modules				
Page	06.90		06.92	
Contacts	Han-Quintax® contact 4 + shielding 	High Density Quintax contact 8 + shielding 	Han D® Coax contact 1 + shielding 75 Ω 	Han E® Coax contact 1 + shielding 50 Ω 
Series	Han® Multi module			
Number of contacts	4		12	
Modules				
Page	06.94		06.96	
Contacts	FOC contacts  Multimode F.O. HCS®* / PCF F.O. 1 mm POF	Coaxial contacts  50 Ω RG 174 75 Ω RG 179 50 Ω RG 58	FOC contacts  Multimode F.O. HCS®* / PCF F.O. 1 mm POF	Coaxial contacts  50 Ω RG 174 75 Ω RG 179
Series	Han® Pneumatic module			
Number of contacts	2	3		
Modules				
Page	06.100		06.102	
Contacts	 Ø 6.0 mm	 Ø 1.6 mm Ø 3.0 mm Ø 4.0 mm		
Series	Han® SC module	Han-Elisa®	Dummy module	
Number of contacts	4			
Modules				
Page	06.104	06.106	06.114	
	SC contact for GI 50; 62.5 / 125 µm 	Temperature I/O modules ID module		

\* HCS® = Hard Clad Silica (is registered trade mark of the SpecTran Corporation)

## Features

- Compact design saves space
- Modular structure increases flexibility
- Simple and quick assembly
- Robust design
- Two part grommet housing

## Technical characteristics

### Hoods/Housings

Material	zinc die-cast
Surface	nickel plated
Locking element	stainless steel
Hoods/Housings sealing	NBR
Limiting temperatures	-40 °C ... +125 °C
Degree of protection acc. to DIN EN 60 529	
for coupled connector	IP 65
Mechanical working life	
- mating cycles	500
PE contact	
wire gauge	10 mm <sup>2</sup> / AWG 8
Stripping length	10 mm
Tightening torque	1 Nm

### Protection covers for housings, bulkhead mounting

Material	polycarbonate
Locking element	Polyamide
Hoods/Housings sealing	NBR
Limiting temperatures	-40 °C ... +125 °C
Degree of protection acc. to DIN EN 60 529	
for coupled connector	IP 65
Flammability acc. to UL 94	V 0

## Current carrying capacity

The current carrying capacity of the connectors is limited by the thermal load capability of the contact element material including the connections and the insulating parts. The derating curve is therefore valid for currents which flow constantly (non-intermittent) through each contact element of the connector evenly, without exceeding the allowed maximum temperature.

Measuring and testing techniques according to DIN EN 60 512-5

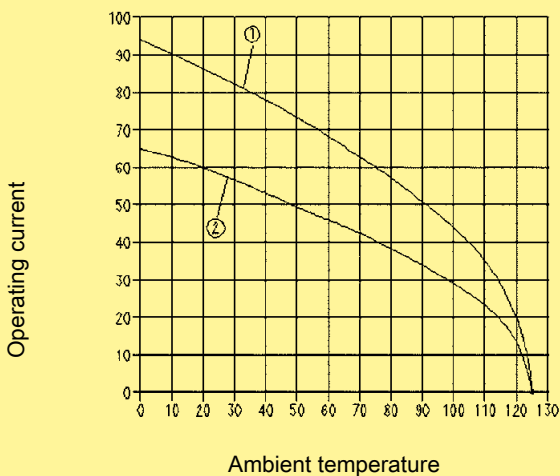

① Han® 40 A Axial module, wire gauge: 10 mm<sup>2</sup>

② Han® C module, wire gauge: 6 mm<sup>2</sup>

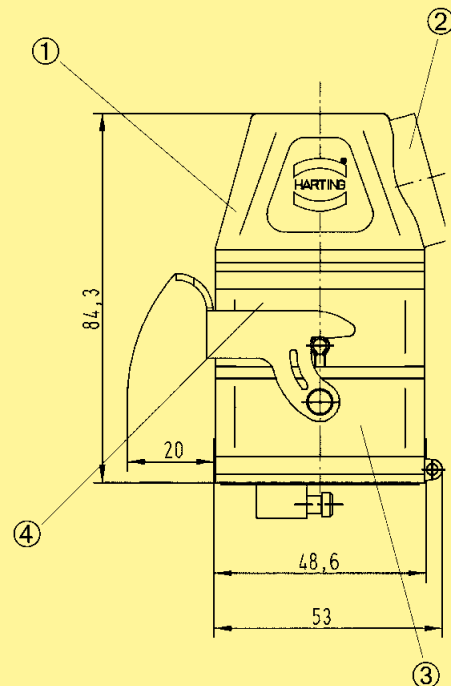







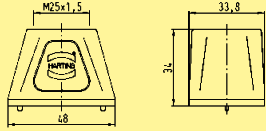

① Hood with side entry

② Thread M25

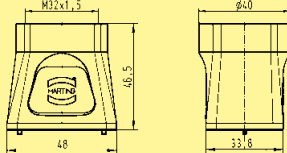
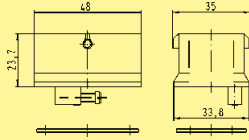
③ Bulkhead mounted housing with locking lever

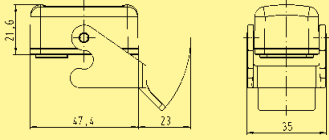
④ Carrier hood

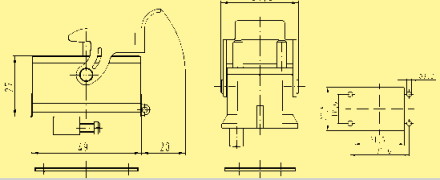
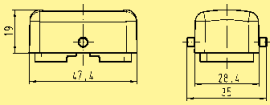
Identification	Part number	Drawing	Dimensions in mm
Hoods side entry M25 	<b>19 14 001 0501</b>	4 screws are included in the delivery range 	
Hoods top entry M25 	<b>19 14 001 0401</b>	4 screws are included in the delivery range 	
Hoods top entry M32 	<b>19 14 001 0402</b>	4 screws are included in the delivery range 	
Carrier hood 	<b>09 14 001 0311</b>		
Protection covers 	<b>09 14 001 5402</b>		
Housings, bulkhead mounting 	<b>09 14 001 0301</b>		Panel cut out
Protection covers for housings, bulkhead mounting 	<b>09 14 001 5401</b>		

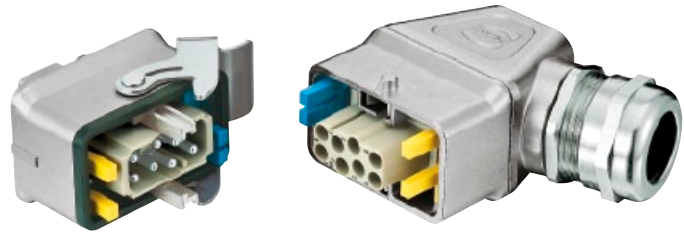

## Coding pins

Han  
Modular

Identification	Part number	Drawing	Dimensions in mm
----------------	-------------	---------	------------------

Coding pin 1 (red)



09 14 000 9971

Coding pin 2 (blue)



09 14 000 9972

Coding pin 3 (black)



0914 000 9973

Coding pin 4 (yellow)



09 14 000 9974

## 16 Coding options

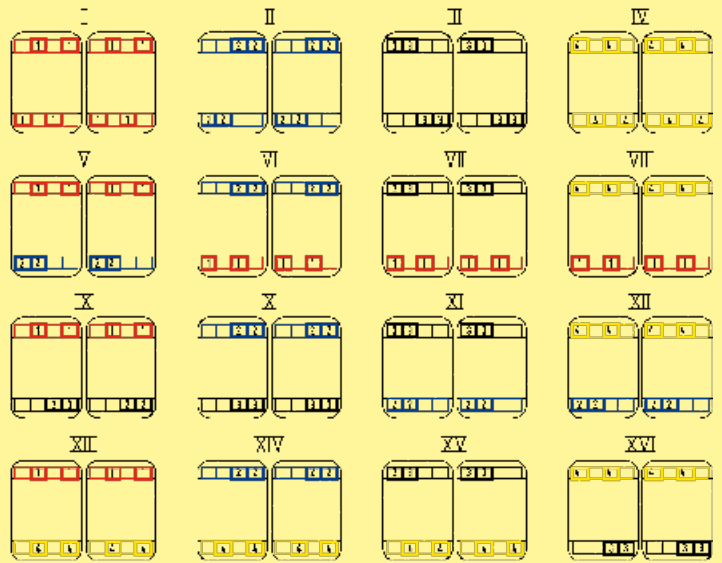



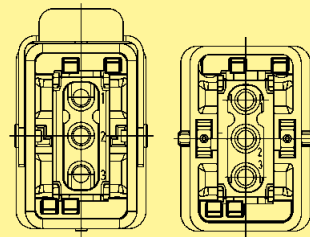

Example for coding option IV



Remark

Coding pins can be retro fitted from the front.

-  09 14 000 9971 red
-  09 14 000 9972 blue
-  09 14 000 9973 black
-  09 14 000 9974 yellow

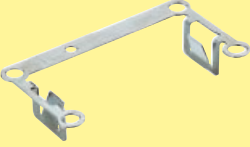
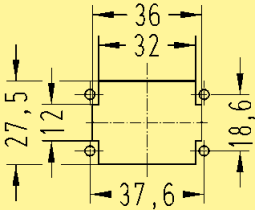
Identification	Part number	Drawing	Dimensions in mm
<p>Fixing bracket for Han-Modular® Compact</p> 	<p><b>09 14 000 9947</b></p>	 <p>1 Panel cut out</p>	

Han  
Modular

## Features

- Compact and space saving
- High degree of flexibility due to modular assembly
- Easy and quick assembly
- Robust design
- Hood consists of two parts

## Technical characteristics





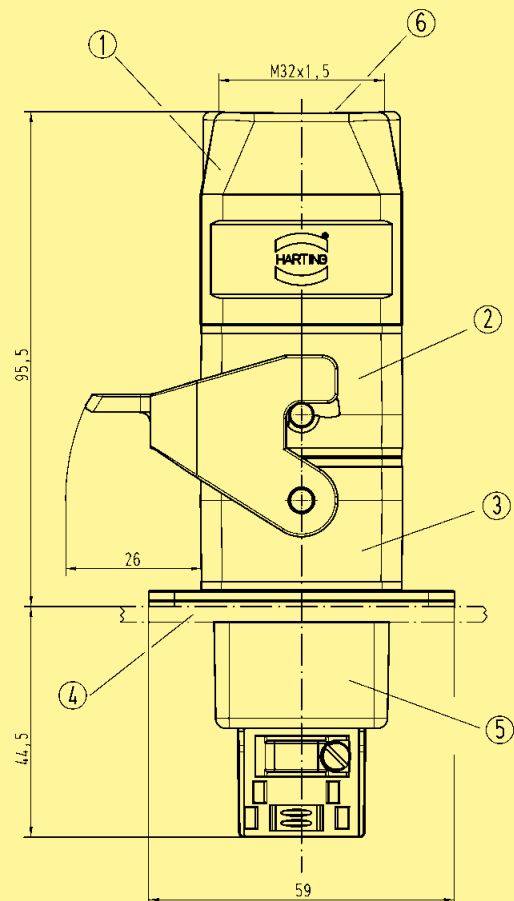

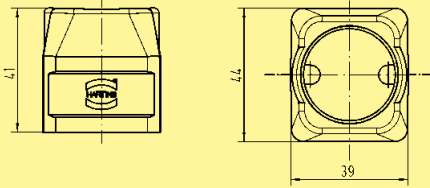

### Hoods/Housings

Material	aluminium die-cast
Surface	powder-coated
Locking element	Han-Easy Lock®
Material	
Panel feed through housing / Shielding frame	zinc die-cast
Hoods/Housings seal	NBR
Limiting temperatures	-40 °C ... +125 °C
Degree of protection acc. to DIN EN 60 529	
for coupled connector	IP 65
Mechanical working life	
- mating cycles	≥ 500
PE contact	
wire gauge	10 mm <sup>2</sup> / AWG 8
Stripping length	10 mm
Tightening torque	1 Nm

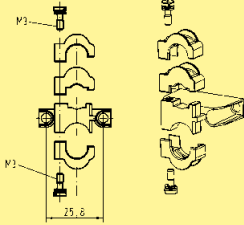

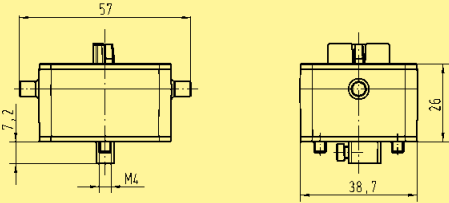

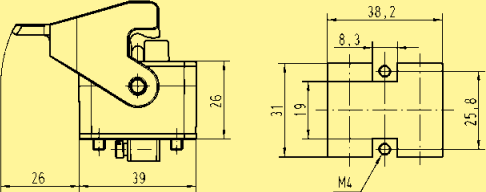

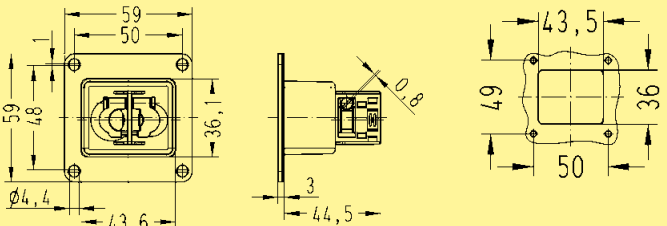

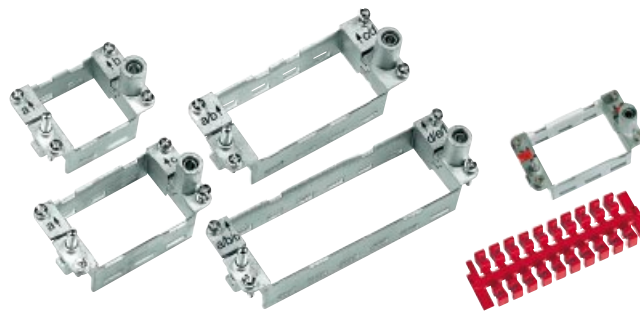

- ① Hood with top entry
- ② Carrier hood
- ③ Bulkhead mounted housing with locking lever
- ④ Switch board panel
- ⑤ Panel feed through housing
- ⑥ Thread M32

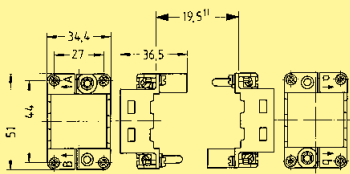
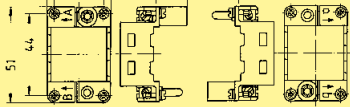

Identification	Part number	Drawing	Dimensions in mm
<p>Hoods</p> <p>top entry M32</p> 	<p><b>19 14 002 0402</b></p>		
<p>Shielding frame</p> 	<p><b>09 14 000 9924</b></p>		
<p>Carrier hood</p> 	<p><b>09 14 002 0311</b></p>		
<p>Housings, bulkhead mounting</p> 	<p><b>09 14 002 0301</b></p>	<p>Panel cut out</p> 	
<p>Panel feed through housings</p> 	<p><b>09 14 000 9928</b></p>	<p>Panel cut out</p> 	

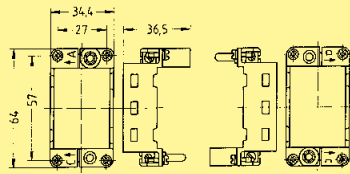
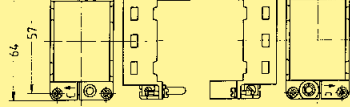

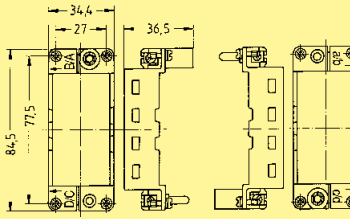
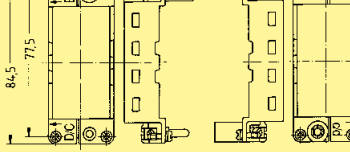

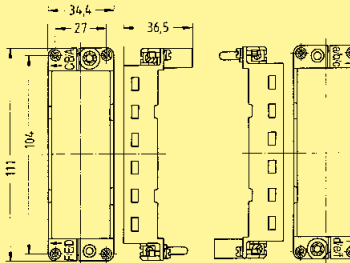
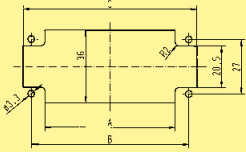
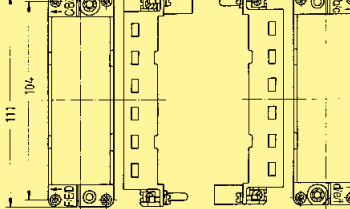
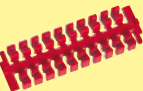
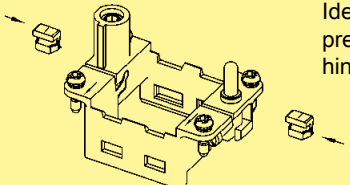
Identification	Part number for Hood/Housing 2)			Drawing	Dimensions in mm																				
	Size	Marking A ... F	Marking a ... f																						
Hinged frame for 2 modules 	<b>6 B</b>	<b>09 14 006 0303</b>	<b>09 14 006 0313</b>	Hoods 	Housings 																				
Hinged frame for 3 modules 	<b>10 B</b>	<b>09 14 010 0303</b>	<b>09 14 010 0313</b>																						
Hinged frame for 4 modules 	<b>16 B</b>	<b>09 14 016 0303</b>	<b>09 14 016 0313</b>																						
Hinged frame for 6 modules 	<b>24 B</b>	<b>09 14 024 0303</b>	<b>09 14 024 0313</b>	 Panel cut out  <table border="1" data-bbox="992 1729 1465 1886"> <thead> <tr> <th>Size</th> <th>A</th> <th>B</th> <th>C</th> </tr> </thead> <tbody> <tr> <td><b>6 B</b></td> <td>35</td> <td>44</td> <td>52</td> </tr> <tr> <td><b>10 B</b></td> <td>49</td> <td>57</td> <td>66</td> </tr> <tr> <td><b>16 B</b></td> <td>64</td> <td>77.5</td> <td>85.5</td> </tr> <tr> <td><b>24 B</b></td> <td>94</td> <td>104</td> <td>112</td> </tr> </tbody> </table>	Size	A	B	C	<b>6 B</b>	35	44	52	<b>10 B</b>	49	57	66	<b>16 B</b>	64	77.5	85.5	<b>24 B</b>	94	104	112	
Size	A	B	C																						
<b>6 B</b>	35	44	52																						
<b>10 B</b>	49	57	66																						
<b>16 B</b>	64	77.5	85.5																						
<b>24 B</b>	94	104	112																						
Locking element for hinged frames (20 pieces per bloc) 		<b>09 14 000 9960</b>	<b>09 14 000 9960</b>		Ideal to pre-assemble the hinged frames																				

Han Modular

1) Distance max. 20.5 mm  
 2) Hinged frames can be used either in hood or housing  
 Both different markings must be used for one connector!

Stock items in bold type

## Features

- Blind mating connector system for drawer systems
- Direct panel mounting without housing
- Very robust design
- Solid pre-leading guid pins and float bushes
- Can be fixed with standard M4 screws

### Notice:

Due the plastic material used in the docking frame without PE, the panel will need to be grounded separately





## Technical characteristics

Specifications	DIN EN 60 664-1 DIN EN 61 984
----------------	----------------------------------

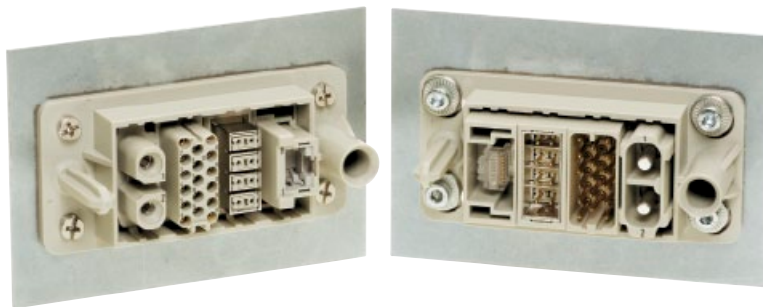
### Docking frames

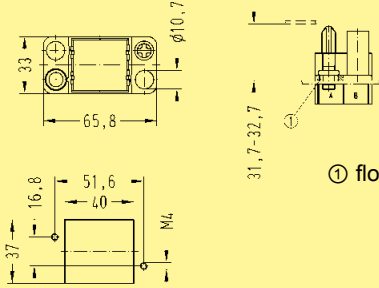
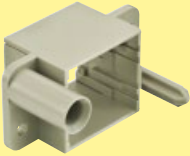
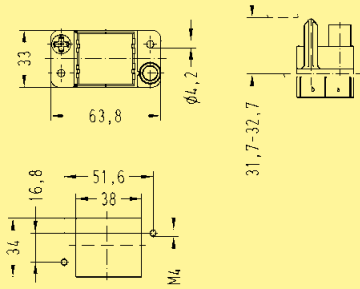
Number of modules	2, 4, 6
Material	
- Docking frames	polycarbonate
- Float washer	zinc die-cast
Floating tolerance	± 2 mm
Aligning tolerance	± 4 mm
Limiting temperatures	-40 °C ... +125 °C
Flammability acc. to UL 94	V 0
Mechanical working life	
- mating cycles	≥ 500

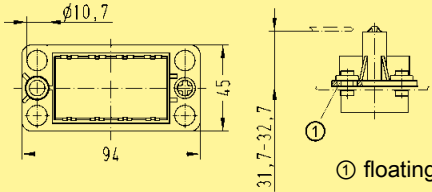

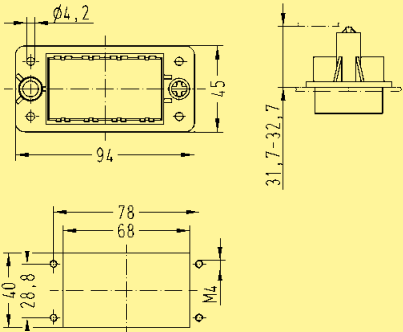

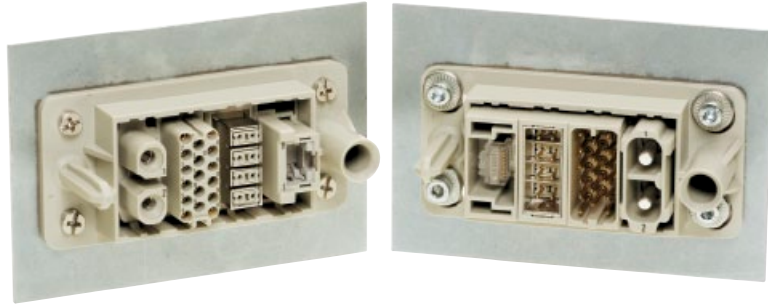

Identification	Part number		Drawing	Dimensions in mm
	Marking A ... F <sup>1)</sup>	Marking a ... f <sup>2)</sup>		
Docking frame for 2 modules 	<b>09 14 006 1701</b>			① floating tolerance $\pm 2$ mm  Panel cut out
Docking frame for 2 modules 		<b>09 14 006 1711</b>		Panel cut out
Docking frame for 4 modules 	<b>09 14 016 1701</b>			① floating tolerance $\pm 2$ mm
Docking frame for 4 modules 		<b>09 14 016 1711</b>		Panel cut out

1) Float mount  
2) Fixed

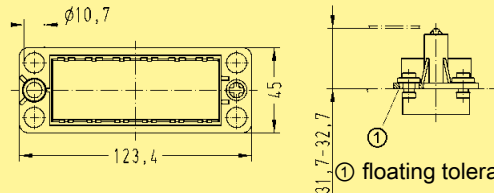

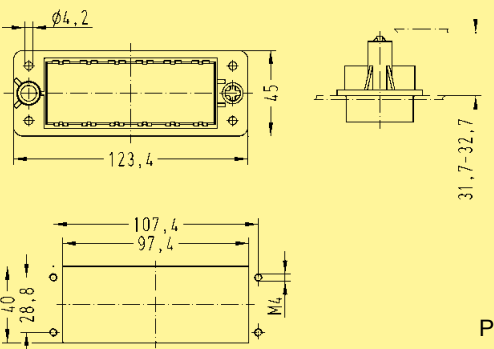
Han  
Modular

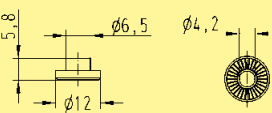
Identification	Part number		Drawing	Dimensions in mm
	Marking A ... F <sup>1)</sup>	Marking a ... f <sup>2)</sup>		
Docking frame for 6 modules 	<b>09 14 024 1701</b>		 <p>① floating tolerance <math>\pm 2</math> mm</p>	
Docking frame for 6 modules 		<b>09 14 024 1711</b>	 <p>Panel cut out</p>	
Float washer to enable the frame to be float mounted using standard M4 fixing screws 	<b>09 14 000 9936</b>			

1) Float mount  
2) Fixed

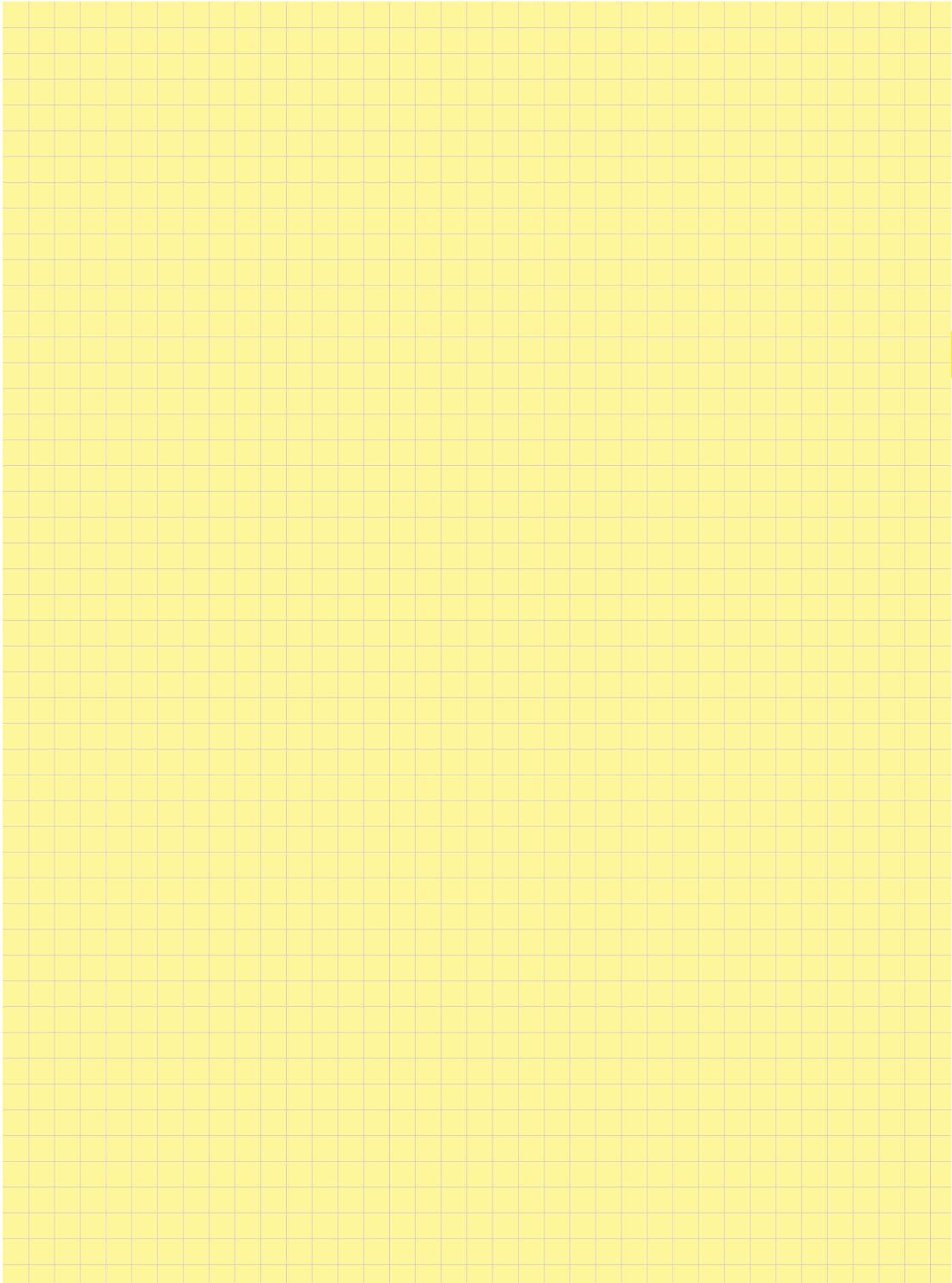

## Features

- Suitable for all Han-Modular® single modules
- The variant with PE connection uses pin 1 of the module as PE
- Slim, space saving design
- Low cost plastic hoods and housings

## Technical characteristics





Specifications	DIN EN 60 664-1 DIN EN 61 984
----------------	----------------------------------

### Hoods/Housings

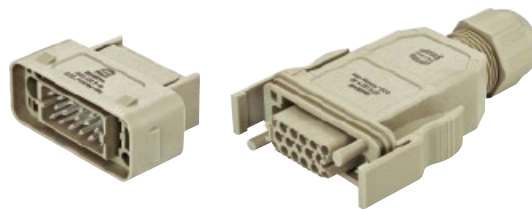
Material	
- Hoods/Housings	polycarbonate
- Seal	NBR
- Cable seal	Polyamide
Limiting temperatures	-40 °C ... +85 °C
Flammability acc. to UL 94	V 0
Degree of protection acc. to DIN EN 60 529 for coupled connector	IP 20 / IP 65
Mechanical working life	
- mating cycles	≥ 500

Plastic hoods/housings  
with PE marking







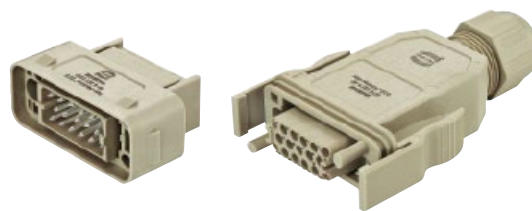

Identification	Part number	Drawing	Dimensions in mm
Hoods with PE marking (pin 1 = PE) IP 65 top entry 	<b>09 14 001 0421</b>		
Hoods with PE marking (pin 1 = PE) IP 20 top entry 	<b>09 14 001 0423</b>		
Housing, bulkhead mounting with PE marking (pin 1 = PE) IP 20 / IP 65 	<b>09 14 001 0321</b>		Panel cut out
Coding pin 	<b>09 14 000 9929</b>		Range of delivery: 8 pieces per frame

Han  
Modular

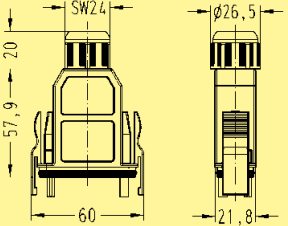

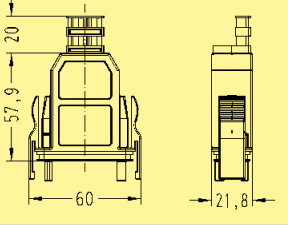
Plastic hoods/housings  
without PE

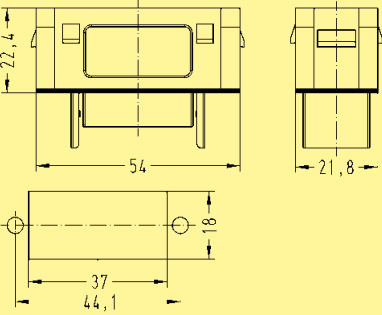
Han  
Modular

Identification	Part number	Drawing	Dimensions in mm
Hoods without PE IP 65 top entry 	<b>09 14 001 0420</b>		
Hoods without PE IP 20 top entry 	<b>09 14 001 0422</b>		
Housing, bulkhead mounting without PE IP 20 / IP 65 	<b>09 14 001 0320</b>		Panel cut out
Coding pin 	<b>09 14 000 9929</b>		Range of delivery: 8 pieces per frame

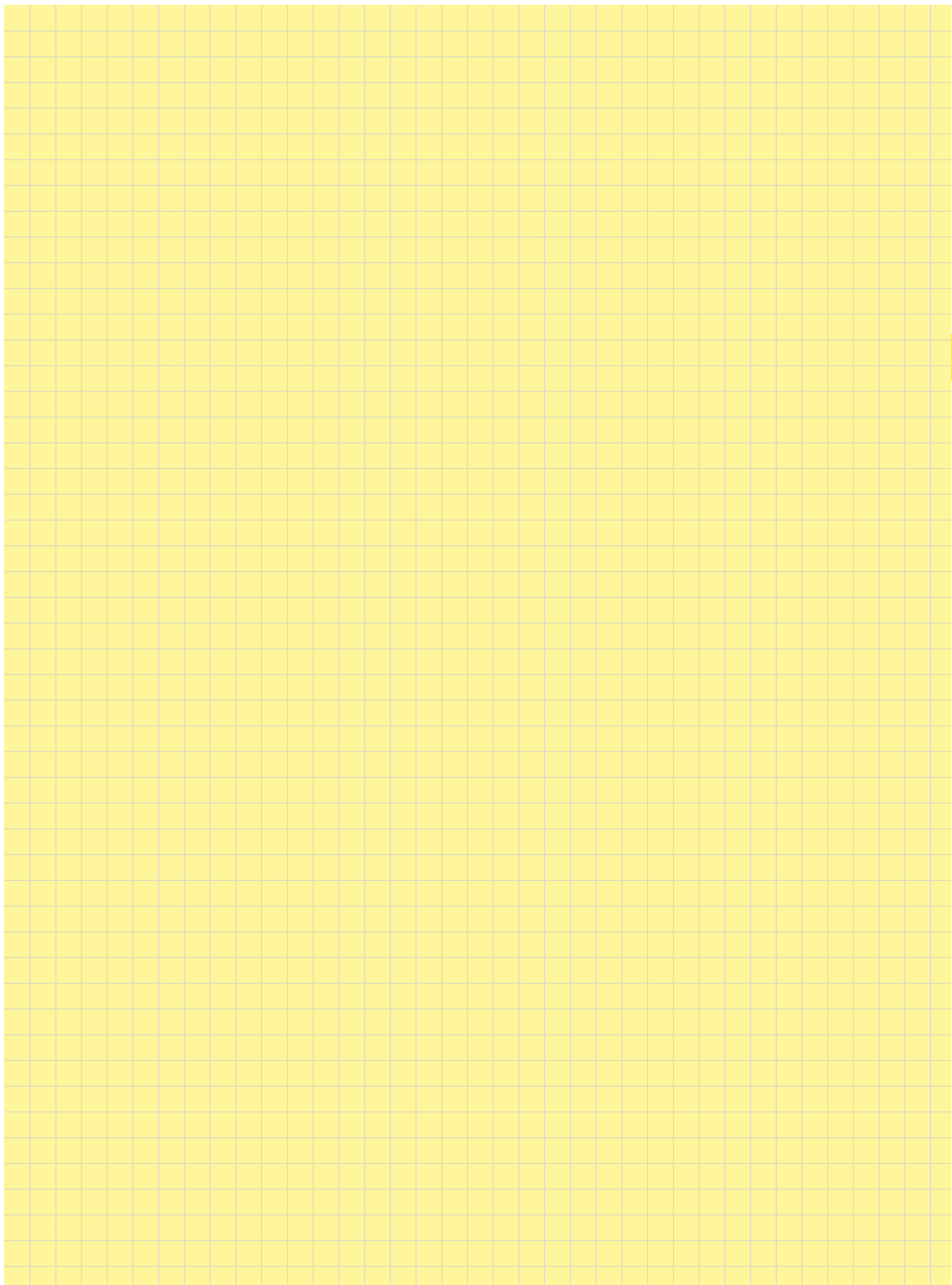



Number of contacts

**1**

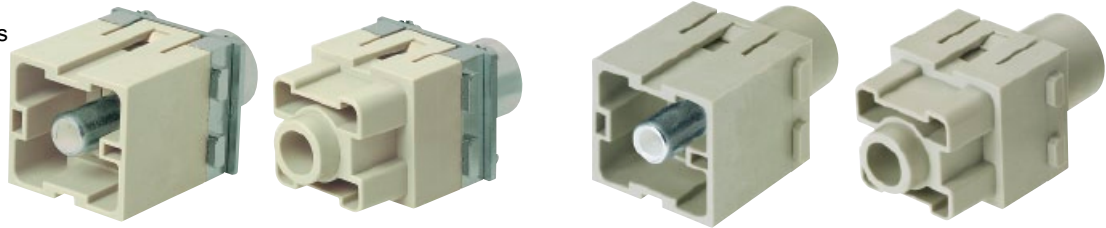

Identification	Part number		Drawing	Dimensions in mm
	Male insert (M)	Female insert (F)		
Axial screw terminal 200 A				
25 ... 40 mm <sup>2</sup>	<b>09 14 001 2663</b>	<b>09 14 001 2763</b>		
40 ... 70 mm <sup>2</sup>	<b>09 14 001 2662</b>	<b>09 14 001 2762</b>		
Axial screw terminal 200 A PE (Ground)				
25 ... 40 mm <sup>2</sup>	<b>09 14 001 2668</b>	<b>09 14 001 2768</b>		
40 ... 70 mm <sup>2</sup>	<b>09 14 001 2667</b>	<b>09 14 001 2767</b>		

Han  
Modular

Identification	Part number	Drawing	Dimensions in mm
Hex key SW 5 for axial setscrew			
with grip	<b>09 99 000 0364</b>		
adapter 3/8"	<b>09 99 000 0371</b>		

## Features

- Crimp termination
- Contacts can be unlocked from the mating side
- Compatible with Han® 200 A modules with axial screw terminal

## Technical characteristics

Specifications	EN 50 124-1 DIN EN 60 664-1 DIN EN 61 984
----------------	---

### Inserts

Number of contacts	1
Electrical data acc. to EN 61 984	<b>200 A 1000 V 8 kV 3</b>
Rated current	200 A
Rated voltage	1000 V
Rated impulse voltage	8 kV
Pollution degree	3
Insulation resistance	$\geq 10^{10} \Omega$
Material	polycarbonate
Limiting temperatures	-40 °C ... +125 °C
Flammability acc. to UL 94	V 0
Mechanical working life - mating cycles	$\geq 500$

### Contacts

Material	copper alloy
Surface	
- hard-silver plated	3 $\mu\text{m}$ Ag
Contact resistance	$\leq 0.3 \text{ m}\Omega$
Crimp terminal	
- $\text{mm}^2$	25 ... 70 $\text{mm}^2$
Max. insulation diameter	18 mm

## Current carrying capacity

The current carrying capacity of the connectors is limited by the thermal load capability of the contact element material including the connections and the insulating parts. The derating curve is therefore valid for currents which flow constantly (non-intermittent) through each contact element of the connector evenly, without exceeding the allowed maximum temperature.

Measuring and testing techniques according to DIN EN 60 512-5

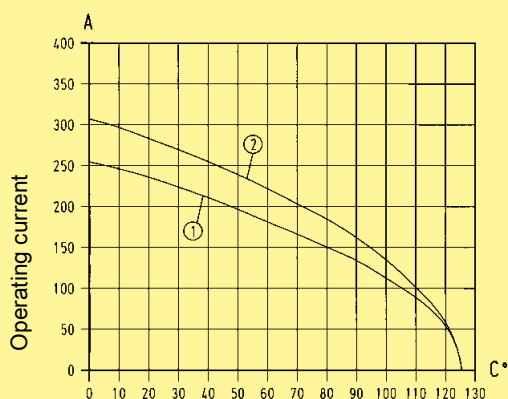

Ambient temperature

- ① 24 B hoods/housings with 3 modules; wire gauge: 50  $\text{mm}^2$   
 ② 24 B hoods/housings with 3 modules; wire gauge: 70  $\text{mm}^2$

Number of contacts

# 1

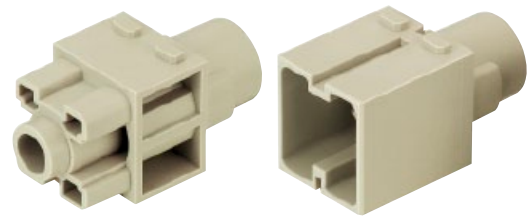

Identification	Part number		Drawing	Dimensions in mm
	Male insert (M)	Female insert (F)		
Crimp terminal Modul	<b>09 14 001 3001</b>	<b>09 14 001 3101</b>		

Han Modular

Identification	Wire gauge (mm <sup>2</sup> )	Part number		Drawing	Dimensions in mm															
		Male contact	Female contact																	
Crimp contacts* silver plated																				
	25	<b>09 11 000 6120</b>	<b>09 11 000 6220</b>																	
	35	<b>09 11 000 6121</b>	<b>09 11 000 6221</b>																	
	50	<b>09 11 000 6122</b>	<b>09 11 000 6222</b>																	
	70	<b>09 11 000 6123</b>	<b>09 11 000 6223</b>																	
				<table border="1"> <thead> <tr> <th>Wire gauge</th> <th>∅</th> <th>Stripping length A</th> </tr> </thead> <tbody> <tr> <td>25 mm<sup>2</sup></td> <td>7</td> <td>19 mm</td> </tr> <tr> <td>35 mm<sup>2</sup></td> <td>8.2</td> <td>20 mm</td> </tr> <tr> <td>50 mm<sup>2</sup></td> <td>10</td> <td>22.5 mm</td> </tr> <tr> <td>70 mm<sup>2</sup></td> <td>11.5</td> <td>22.5 mm</td> </tr> </tbody> </table>	Wire gauge	∅	Stripping length A	25 mm <sup>2</sup>	7	19 mm	35 mm <sup>2</sup>	8.2	20 mm	50 mm <sup>2</sup>	10	22.5 mm	70 mm <sup>2</sup>	11.5	22.5 mm	
Wire gauge	∅	Stripping length A																		
25 mm <sup>2</sup>	7	19 mm																		
35 mm <sup>2</sup>	8.2	20 mm																		
50 mm <sup>2</sup>	10	22.5 mm																		
70 mm <sup>2</sup>	11.5	22.5 mm																		
				for stranded wire according to IEC 60 228 Class 5																

\* Crimp zone acc. to DIN EN 46 235



Number of contacts

# 2

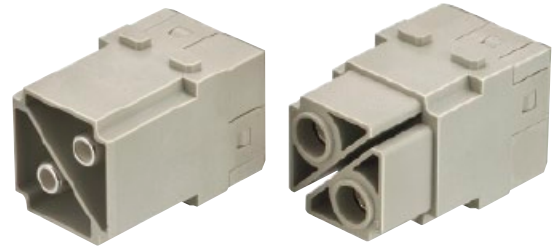

Identification	Part number		Drawing	Dimensions in mm
	Male insert (M)	Female insert (F)		
Axial screw terminal 100 A				
10 ... 25 mm <sup>2</sup>	<b>09 14 002 2653</b>	<b>09 14 002 2753</b>		
16 ... 35 mm <sup>2</sup>	<b>09 14 002 2651</b>	<b>09 14 002 2751</b>		
38 mm <sup>2</sup>	09 14 002 2650	09 14 002 2750		

Han  
Modular

Identification	Part number	Drawing	Dimensions in mm
Hex key SW 4 for axial setscrew			
with grip	<b>09 99 000 0363</b>		
adapter 3/8"	<b>09 99 000 0370</b>		
Cable shoe 16 mm <sup>2</sup> for PE extension			
Comment for hoods/ housings high construction only	<b>09 14 000 9912</b>		Please use pressing tools for non-insulated cable shoes fol- lowing DIN 46 230 with 16 mm <sup>2</sup> range (eg. K25, co. Klauke)

06  
29

Stock items in bold type

## Features

- Crimp termination
- Unlock of contacts from mating side
- Connect PE contact with special cable shoe
- Compatible to Han® 100 A module with axial screw terminal

## Technical characteristics

Specifications                      DIN EN 60 664-1  
     DIN EN 61 984

Approvals                             

### Inserts

Number of contacts                      2  
 Electrical data  
 acc. to EN 61 984                      **100 A 1000 V 8 kV 3**  
 Rated current                              100 A  
 Rated voltage                              1000 V  
 Rated impulse voltage                    8 kV  
 Pollution degree                          3

Rated voltage  
 acc. to UL                                  600 V  
 Insulation resistance                       $\geq 10^{10} \Omega$   
 Material                                      polycarbonate  
 Limiting temperatures                    -40 °C ... +125 °C  
 Flammability acc. to UL 94              V 0  
 Mechanical working life  
 - mating cycles                               $\geq 500$

### Contacts

Material                                      copper alloy  
 Surface  
 - hard-silver plated                      3  $\mu\text{m}$  Ag  
 Contact resistance                         $\leq 0.3 \text{ m}\Omega$   
 Crimp terminal  
 -  $\text{mm}^2$                                       10 ... 35  $\text{mm}^2$   
 Max. cable diameter                      14 mm

### Crimp zone (C)

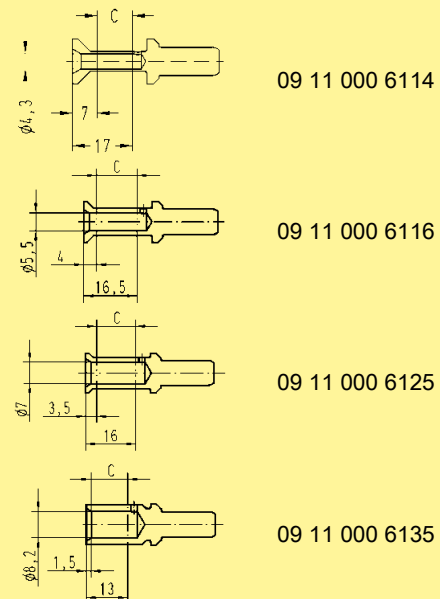

## Current carrying capacity

The current carrying capacity of the connectors is limited by the thermal load capability of the contact element material including the connections and the insulating parts. The derating curve is therefore valid for currents which flow constantly (non-intermittent) through each contact element of the connector evenly, without exceeding the allowed maximum temperature.

Measuring and testing techniques according to DIN EN 60 512-5

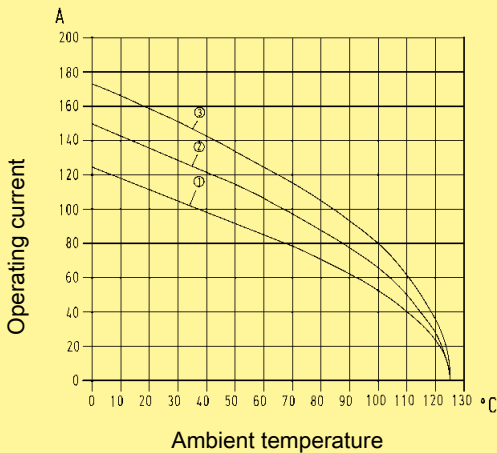

- ① 24 B hoods/housings with 3 modules; wire gauge: 16  $\text{mm}^2$
- ② 24 B hoods/housings with 3 modules; wire gauge: 25  $\text{mm}^2$
- ③ 24 B hoods/housings with 3 modules; wire gauge: 35  $\text{mm}^2$

Number of contacts

# 2

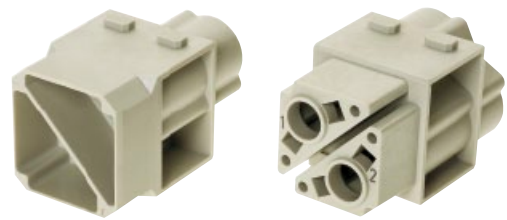

Identification	Part number		Drawing	Dimensions in mm
	Male insert (M)	Female insert (F)		
Crimp terminal Modul	<b>09 14 002 3051</b>	<b>09 14 002 3151</b>		
Removal tool for TC contacts	<b>09 99 000 0383</b>	<b>09 99 000 0383</b>		

Han Modular

Identification	Wire gauge (mm <sup>2</sup> )	Part number		Drawing	Dimensions in mm
		Male contact	Female contact		
Crimp contacts* silver plated					
	10	<b>09 11 000 6114</b>	<b>09 11 000 6214</b>		
	16	<b>09 11 000 6116</b>	<b>09 11 000 6216</b>		
	25	<b>09 11 000 6125</b>	<b>09 11 000 6225</b>		
	35	<b>09 11 000 6135</b>	<b>09 11 000 6235</b>		

Wire gauge	Ø	Stripping length (A)
10 mm <sup>2</sup>	4.3	19 mm
16 mm <sup>2</sup>	5.5	19 mm
25 mm <sup>2</sup>	7.0	19 mm
35 mm <sup>2</sup>	8.2	16 mm

for stranded wire acc. to IEC 60 228 Class 5

\* Crimp zone acc. to DIN EN 46 235

## Features

- Crimp or axial screw termination available
- Unlock of contacts with a screw driver from mating side
- Connect PE contact with special cable shoe (see chapter 40 in the main catalogue „Industrial Connectors Han®)
- Separate axial screw contacts can be terminated without any special tools directly to the wire.

## Technical characteristics

Specifications DIN EN 60 664-1  
DIN EN 61 984

### Inserts

Number of contacts 1  
 Electrical data acc. to EN 61 984 **100 A 830 V 8 kV 3**  
 Rated current 100 A  
 Rated voltage 830 V  
 Rated impulse voltage 8 kV  
 Pollution degree 3

Insulation resistance ≥ 10<sup>10</sup> Ω  
 Material polycarbonate  
 Limiting temperatures -40 °C ... +125 °C  
 Flammability acc. to UL 94 V 0  
 Mechanical working life  
   - mating cycles ≥ 500  
 Max. insulation diameter 13 mm

### Crimp Contacts

Material copper alloy  
 Surface  
   - hard-silver plated 3 μm Ag  
 Contact resistance ≤ 0.3 mΩ  
 Crimp terminal  
   - wire gauge 10 ... 35 mm<sup>2</sup>

### Axial Screw Contacts

Material copper alloy  
 Surface  
   - hard-silver plated 3 μm Ag  
 Contact resistance ≤ 0.3 mΩ  
 Screw terminal  
   - wire gauge<sup>1)</sup> 10 ... 35 mm<sup>2</sup>  
   - AWG 6 ... 2  
   - hexagonal driver SW 4  
   - tightening torque

mm <sup>2</sup>	10	16	25	35
Nm	6	6	7	8

Number of contacts

# 1

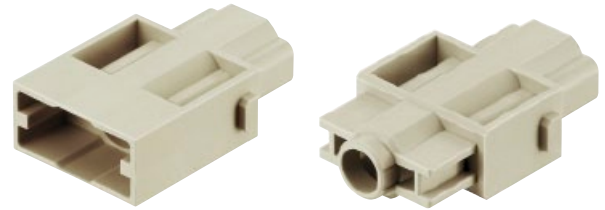

Identification	Part number		Drawing	Dimensions in mm
	Male insert (M)	Female insert (F)		
100 A single module order contacts separately	<b>09 14 001 3031</b>	<b>09 14 001 3131</b>	<p>view termination side</p>	

Han  
Modular

Identification	Wire gauge (mm <sup>2</sup> )	Part number		Drawing	Dimensions in mm															
		Male contact	Female contact																	
<b>Contacts</b> axial screw terminal 	10-25 16-35	<b>09 11 000 6112</b> <b>09 11 000 6113</b>	<b>09 11 000 6212</b> <b>09 11 000 6213</b>	<p>Stripping length 13 mm</p>																
crimp terminal* 	10 16 25 35	<b>09 11 000 6114</b> <b>09 11 000 6116</b> <b>09 11 000 6125</b> <b>09 11 000 6135</b>	<b>09 11 000 6214</b> <b>09 11 000 6216</b> <b>09 11 000 6225</b> <b>09 11 000 6235</b>		<table border="1"> <thead> <tr> <th>Wire gauge</th> <th>Ø</th> <th>Stripping length (A)</th> </tr> </thead> <tbody> <tr> <td>10 mm<sup>2</sup></td> <td>4.3</td> <td>19 mm</td> </tr> <tr> <td>16 mm<sup>2</sup></td> <td>5.5</td> <td>19 mm</td> </tr> <tr> <td>25 mm<sup>2</sup></td> <td>7.0</td> <td>19 mm</td> </tr> <tr> <td>35 mm<sup>2</sup></td> <td>8.2</td> <td>16 mm</td> </tr> </tbody> </table> <p>for stranded wire acc. to IEC 60 228 Class 5</p>	Wire gauge	Ø	Stripping length (A)	10 mm <sup>2</sup>	4.3	19 mm	16 mm <sup>2</sup>	5.5	19 mm	25 mm <sup>2</sup>	7.0	19 mm	35 mm <sup>2</sup>	8.2	16 mm
Wire gauge	Ø	Stripping length (A)																		
10 mm <sup>2</sup>	4.3	19 mm																		
16 mm <sup>2</sup>	5.5	19 mm																		
25 mm <sup>2</sup>	7.0	19 mm																		
35 mm <sup>2</sup>	8.2	16 mm																		

\* Crimp zone acc. to DIN EN 46 235

## Features

- Axial-screw termination
- 2 contacts (70 A) for power circuits
- Male inserts with protection collar
- Male and female contacts are finger safe
- Compatible to Han® 70 A module with crimp terminal

## Technical characteristics

Specifications DIN EN 60 664-1  
DIN EN 61 984

Approvals

### Inserts

Number of contacts 2  
 Electrical data  
 acc. to EN 61 984 **70 A 1000 V 8 kV 3**  
 Rated current 70 A  
 Rated voltage 1000 V  
 Rated impulse voltage 8 kV  
 Pollution degree 3

Rated voltage  
 acc. to UL 600 V  
 Insulation resistance ≥ 10<sup>10</sup> Ω  
 Material polycarbonate  
 Limiting temperatures -40 °C ... +125 °C  
 Flammability acc. to UL 94 V 0  
 Mechanical working life  
 - mating cycles ≥ 500

### Contacts

Material copper alloy  
 Surface 3 μm Ag  
 - hard-silver plated  
 Contact resistance 0.5 mΩ  
 Screw terminal  
 - Wire gauge <sup>1)</sup> 6 ... 22 mm<sup>2</sup>  
 - AWG 8 ... 4  
 - Hexagonal driver SW 2.5  
 - Stripping length

mm <sup>2</sup>	6	10	16	22
mm	11 <sup>+1</sup>	11 <sup>+1</sup>	11 <sup>+1</sup>	12.5 <sup>+1</sup>

- Tightening torque

mm <sup>2</sup>	6	10	16	22
Nm	2	3	4	5

### Current carrying capacity

The current carrying capacity of the connectors is limited by the thermal load capability of the contact element material including the connections and the insulating parts. The derating curve is therefore valid for currents which flow constantly (non-intermittent) through each contact element of the connector evenly, without exceeding the allowed maximum temperature.

Measuring and testing techniques according to DIN EN 60 512-5

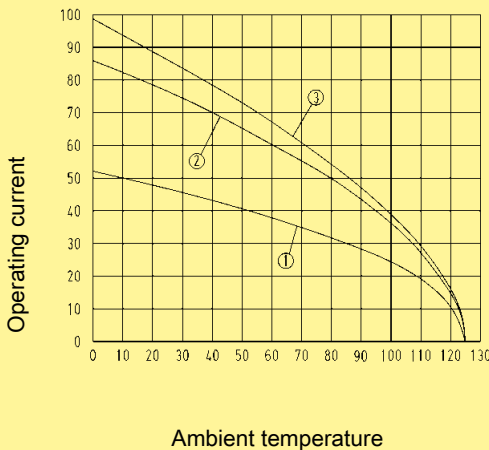

- ① 24 B hoods/housings with 6 modules; wire gauge: 6 mm<sup>2</sup>
- ② 24 B hoods/housings with 6 modules; wire gauge: 16 mm<sup>2</sup>
- ③ 24 B hoods/housings with 6 modules; wire gauge: 22 mm<sup>2</sup>

1) geometric wire gauge

Number of contacts

# 2



Identification	Part number		Drawing	Dimensions in mm
	Male insert (M)	Female insert (F)		
Axial screw terminal 70 A				
6 ... 16 mm <sup>2</sup>	<b>09 14 002 2646</b>	<b>09 14 002 2741</b>		
14 ... 22 mm <sup>2</sup>	<b>09 14 002 2647</b>	<b>09 14 002 2742</b>		
Axial screw terminal 70 A with finger protected male contacts				
6 ... 16 mm <sup>2</sup>	<b>09 14 002 2641</b>			
14 ... 22 mm <sup>2</sup>	<b>09 14 002 2642</b>			

Han  
Modular

Identification	Part number	Drawing	Dimensions in mm
Hex key SW 2.5 for axial setscrew			
Bit 1/4"	<b>09 99 000 0375</b>		



## Features

- Crimp termination
- Compatible with Han® 70 A module with axial screw termination
- Contacts are removed without tools

## Technical characteristics

Specifications	DIN EN 60 664-1 DIN EN 61 984
----------------	----------------------------------

### Inserts

Number of contacts	2
Electrical data acc. to DIN EN 61 984	<b>70 A 1000 V 8 kV 3</b>
Rated current	70 A
Rated voltage	1000 V
Rated impulse voltage	8 kV
Pollution degree	3
Insulation resistance	$\geq 10^{10} \Omega$
Material	Polycarbonate
Limiting temperatures	-40 °C ... +125 °C
Flammability acc. to UL 94	V 0
Mechanical working life	$\geq 500$ mating cycles

### Contacts

Power contacts	
Material	Copper alloy
Surface	
- hard-silver plated	3 $\mu\text{m}$ Ag
Contact resistance	$\leq 0.5 \text{ m}\Omega$
Crimp terminal	
- wire gauge	10 - 25 mm <sup>2</sup>
Max. insulation diameter	11 mm
Stripping length	15.5 mm

Number of contacts

# 2



Identification	Part-Number		Drawings	Dimensions in mm
	Male insert (M)	Female insert (F)		
Han® 70 A module Crimp terminal	09 14 002 3041	09 14 002 3141		

Han Modular

Identification	Wire gauge mm <sup>2</sup>	Part-Number		Drawings	Dimensions in mm												
		Male contacts (M)	Female contacts (F)														
Crimp contacts* Silver plated	10 16 25	09 11 000 6131 09 11 000 6132 09 11 000 6133	09 11 000 6231 09 11 000 6232 09 11 000 6233		<table border="1"> <thead> <tr> <th>Wire gauge</th> <th>Ø</th> <th>Stripping length</th> </tr> </thead> <tbody> <tr> <td>10 mm<sup>2</sup></td> <td>4.3</td> <td>15.5 mm</td> </tr> <tr> <td>16 mm<sup>2</sup></td> <td>5.5</td> <td>15.5 mm</td> </tr> <tr> <td>25 mm<sup>2</sup></td> <td>7.0</td> <td>15.5 mm</td> </tr> </tbody> </table> <p>for stranded wires acc. to IEC 60 228 class 5</p>	Wire gauge	Ø	Stripping length	10 mm <sup>2</sup>	4.3	15.5 mm	16 mm <sup>2</sup>	5.5	15.5 mm	25 mm <sup>2</sup>	7.0	15.5 mm
Wire gauge	Ø	Stripping length															
10 mm <sup>2</sup>	4.3	15.5 mm															
16 mm <sup>2</sup>	5.5	15.5 mm															
25 mm <sup>2</sup>	7.0	15.5 mm															

\* Crimp zone acc. to DIN EN 46 235

## Features

- Axial-screw termination
- No special tools required
- Compatible to Han® 40 A module with crimp terminal

## Technical characteristics

Specifications                      DIN EN 60 664-1  
   DIN EN 61 984

Approvals                             

### Inserts

Number of contacts                      2  
 Electrical data  
 acc. to EN 61 984                      **40 A 1000 V 8 kV 3**  
 Rated current                              40 A  
 Rated voltage                              1000 V  
 Rated impulse voltage                      8 kV  
 Pollution degree                              3

Rated voltage  
 acc. to UL                                  600 V  
 Insulation resistance                       $\geq 10^{10} \Omega$   
 Material                                      polycarbonate  
 Limiting temperatures                      -40 °C ... +125 °C  
 Flammability acc. to UL 94                      V 0  
 Mechanical working life  
   - mating cycles                               $\geq 500$

### Contacts

Material                                      copper alloy  
 Surface  
   - hard-silver plated                      3  $\mu\text{m}$  Ag  
 Contact resistance                      0.5 m $\Omega$

Screw terminal  
   - Wire gauge <sup>1)</sup>                              2.5 ... 10 mm<sup>2</sup>  
   - AWG    14 ... 8  
   - Hexagonal driver                      SW 2  
   - Stripping length

mm <sup>2</sup>	2.5	4	6	10
mm	5 <sup>+1</sup>	5 <sup>+1</sup>	8 <sup>+1</sup>	11 <sup>+1</sup>

- Tightening torque

mm <sup>2</sup>	2.5	4	6	10
Nm	1.5	1.5	2	2

### Current carrying capacity

The current carrying capacity of the connectors is limited by the thermal load capability of the contact element material including the connections and the insulating parts. The derating curve is therefore valid for currents which flow constantly (non-intermittent) through each contact element of the connector evenly, without exceeding the allowed maximum temperature.

Measuring and testing techniques according to DIN EN 60 512-5

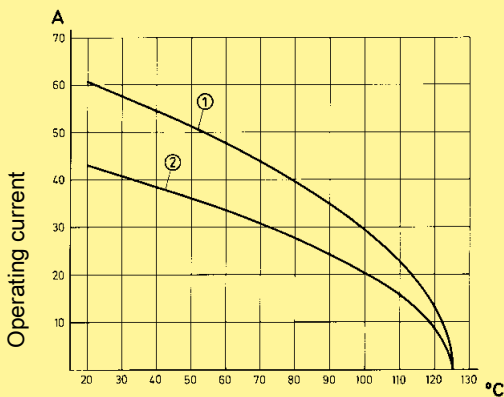

Ambient temperature

① 24 B hoods/housings with 6 modules; wire gauge: 10 mm<sup>2</sup>

② 24 B hoods/housings with 6 modules; wire gauge: 6 mm<sup>2</sup>

Number of contacts

# 2

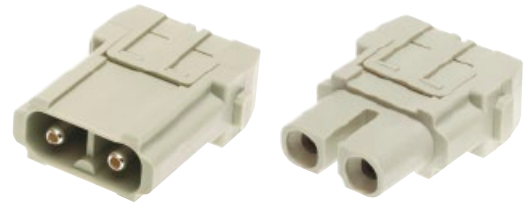

Identification	Part number		Drawing	Dimensions in mm
	Male insert (M)	Female insert (F)		
Axial screw terminal 40 A			<p>34,2    14,6 41,8 40,6 34,2    14,6</p> <p>M</p> <p>F</p> <p>Contact arrangement view from termination side</p>	
2.5 ... 8 mm <sup>2</sup>	<b>09 14 002 2601</b>	<b>09 14 002 2701</b>		
6 ... 10 mm <sup>2</sup>	<b>09 14 002 2602</b>	<b>09 14 002 2702</b>		

Han  
Modular

Identification	Part number	Drawing	Dimensions in mm
Hex key SW 2 for axial setscrew			
with grip	<b>09 99 000 0313</b>		
Bit 1/4"	<b>09 99 000 0369</b>		

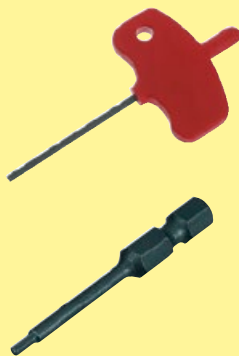



Number of contacts

# 2

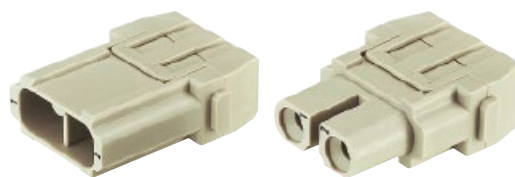

Identification	Part number		Drawing	Dimensions in mm
	Male insert (M)	Female insert (F)		
Crimp terminal Order crimp contacts separately	<b>09 14 002 3002</b>	<b>09 14 002 3102</b>	<p>Contact arrangement view from termination side</p>	

Han Modular

Identification	Wire gauge (mm <sup>2</sup> )	Part number		Drawing	Dimensions in mm																														
		Male contact	Female contact																																
Crimp contacts Power contacts silver plated																																			
	1.5 2.5 4 6 10	<b>09 32 000 6104</b> <b>09 32 000 6105</b> <b>09 32 000 6107</b> <b>09 32 000 6108</b> <b>09 32 000 6109</b>	<b>09 32 000 6204</b> <b>09 32 000 6205</b> <b>09 32 000 6207</b> <b>09 32 000 6208</b> <b>09 32 000 6209</b>		<table border="1"> <thead> <tr> <th colspan="3">Wire gauge</th> <th>∅</th> <th>Stripping length</th> </tr> </thead> <tbody> <tr> <td>1.5</td> <td>mm<sup>2</sup></td> <td>AWG 16</td> <td>1.75</td> <td>9 mm</td> </tr> <tr> <td>2.5</td> <td>mm<sup>2</sup></td> <td>AWG 14</td> <td>2.25</td> <td>9 mm</td> </tr> <tr> <td>4</td> <td>mm<sup>2</sup></td> <td>AWG 12</td> <td>2.85</td> <td>9.6 mm</td> </tr> <tr> <td>6</td> <td>mm<sup>2</sup></td> <td>AWG 10</td> <td>3.5</td> <td>9.6 mm</td> </tr> <tr> <td>10</td> <td>mm<sup>2</sup></td> <td>AWG 8</td> <td>4.3</td> <td>15 mm</td> </tr> </tbody> </table> <p>Stripping length a = 15 mm for cables ≥ 5 mm                      Stripping length a = 18 mm for cables ≥ 6.4 mm</p>	Wire gauge			∅	Stripping length	1.5	mm <sup>2</sup>	AWG 16	1.75	9 mm	2.5	mm <sup>2</sup>	AWG 14	2.25	9 mm	4	mm <sup>2</sup>	AWG 12	2.85	9.6 mm	6	mm <sup>2</sup>	AWG 10	3.5	9.6 mm	10	mm <sup>2</sup>	AWG 8	4.3	15 mm
Wire gauge			∅	Stripping length																															
1.5	mm <sup>2</sup>	AWG 16	1.75	9 mm																															
2.5	mm <sup>2</sup>	AWG 14	2.25	9 mm																															
4	mm <sup>2</sup>	AWG 12	2.85	9.6 mm																															
6	mm <sup>2</sup>	AWG 10	3.5	9.6 mm																															
10	mm <sup>2</sup>	AWG 8	4.3	15 mm																															

## Features

- Axial screw terminal
- No special tools required for assembly
- Compatible to Han® C module with crimp terminal

## Technical characteristics

Specifications DIN EN 60 664-1  
DIN EN 61 984

Approvals

### Inserts

Number of contacts 3  
 Electrical data  
 acc. to EN 61 984 **40 A 690 V 8 kV 3**  
 Rated current 40 A  
 Rated voltage 690 V  
 Rated impulse voltage 8 kV  
 Pollution degree 3

Rated voltage  
 acc. to UL 600 V  
 Insulation resistance ≥ 10<sup>10</sup> Ω  
 Material polycarbonate  
 Limiting temperatures -40 °C ... +125 °C  
 Flammability acc. to UL 94 V 0  
 Mechanical working life  
 - mating cycles ≥ 500

### Contacts

Material copper alloy  
 Surface  
 - hard-silver plated 3 μm Ag  
 Contact resistance 0.3 mΩ

Screw terminal  
 - Wire gauge <sup>1)</sup> 2.5 ... 10 mm<sup>2</sup>  
 - AWG 14 ... 8  
 - Hexagonal driver SW 2  
 - Stripping length

mm <sup>2</sup>	2.5	4	6	10
mm	5 <sup>+1</sup>	5 <sup>+1</sup>	8 <sup>+1</sup>	11 <sup>+1</sup>

- Tightening torque

mm <sup>2</sup>	2.5	4	6	10
Nm	1.5	1.5	2	2

### Current carrying capacity

The current carrying capacity of the connectors is limited by the thermal load capability of the contact element material including the connections and the insulating parts. The derating curve is therefore valid for currents which flow constantly (non-intermittent) through each contact element of the connector evenly, without exceeding the allowed maximum temperature.

Measuring and testing techniques according to DIN EN 60 512-5

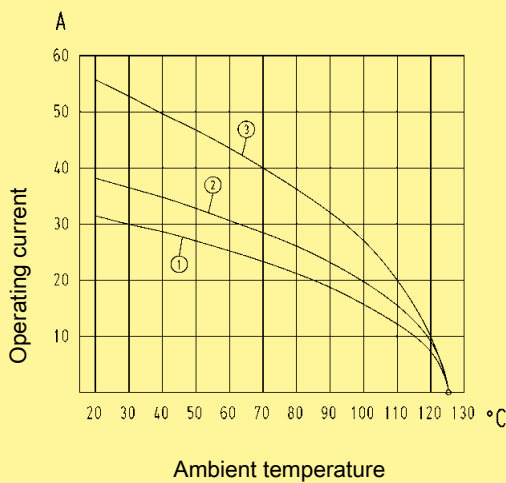

① 24 B hoods/housings with 6 modules; wire gauge: 4 mm<sup>2</sup>

② 24 B hoods/housings with 6 modules; wire gauge: 6 mm<sup>2</sup>

③ 24 B hoods/housings with 6 modules; wire gauge: 10 mm<sup>2</sup>

1) geometric wire gauge

Number of contacts

# 3

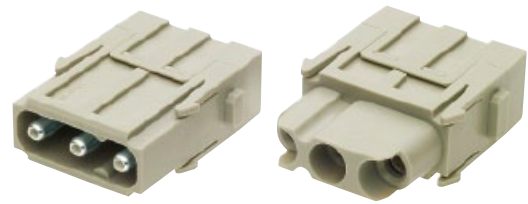

Identification	Part number		Drawing	Dimensions in mm
	Male insert (M)	Female insert (F)		
Axial screw terminal 40 A				
2.5 ... 8 mm <sup>2</sup>	<b>09 14 003 2601</b>	<b>09 14 003 2701</b>		
6 ... 10 mm <sup>2</sup>	<b>09 14 003 2602</b>	<b>09 14 003 2702</b>		

Han  
Modular

Identification	Part number	Drawing	Dimensions in mm
Hex key SW 2 for axial setscrew			
with grip	<b>09 99 000 0313</b>		
Bit 1/4"	<b>09 99 000 0369</b>		





Number of contacts

# 3

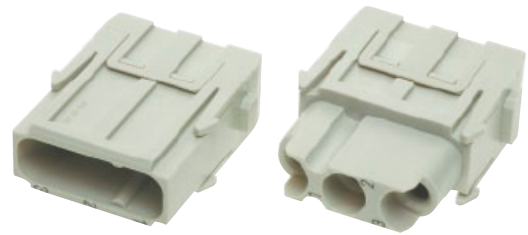

Identification	Part number		Drawing	Dimensions in mm	
	Male insert (M)	Female insert (F)			
Crimp terminal Order crimp contacts separately	09 14 003 3001	09 14 003 3101			$h_M$
				09 14 003 3002	09 14 003 3102
Cable diameter up to 5 mm	09 14 003 3001	09 14 003 3101			$h_F$
Cable diameter up to 7.5 mm	09 14 003 3002	09 14 003 3102			
<p>Contact arrangement view from termination side</p>					

Han Modular

Identification	Wire gauge (mm <sup>2</sup> )	Part number		Drawing	Dimensions in mm																									
		Male contact	Female contact																											
Crimp contacts Power contacts silver plated			09 32 000 6104	09 32 000 6204																										
			09 32 000 6105	09 32 000 6205																										
			09 32 000 6107	09 32 000 6207																										
			09 32 000 6108	09 32 000 6208																										
			09 32 000 6109	09 32 000 6209																										
			10*																											
					<table border="1"> <thead> <tr> <th colspan="2">Wire gauge</th> <th>∅</th> <th>Stripping length</th> </tr> </thead> <tbody> <tr> <td>1.5 mm<sup>2</sup></td> <td>AWG 16</td> <td>1.75</td> <td>9 mm</td> </tr> <tr> <td>2.5 mm<sup>2</sup></td> <td>AWG 14</td> <td>2.25</td> <td>9 mm</td> </tr> <tr> <td>4 mm<sup>2</sup></td> <td>AWG 12</td> <td>2.85</td> <td>9.6 mm</td> </tr> <tr> <td>6 mm<sup>2</sup></td> <td>AWG 10</td> <td>3.5</td> <td>9.6 mm</td> </tr> <tr> <td>10 mm<sup>2</sup></td> <td>AWG 8</td> <td>4.3</td> <td>15 mm</td> </tr> </tbody> </table>	Wire gauge		∅	Stripping length	1.5 mm <sup>2</sup>	AWG 16	1.75	9 mm	2.5 mm <sup>2</sup>	AWG 14	2.25	9 mm	4 mm <sup>2</sup>	AWG 12	2.85	9.6 mm	6 mm <sup>2</sup>	AWG 10	3.5	9.6 mm	10 mm <sup>2</sup>	AWG 8	4.3	15 mm	
Wire gauge		∅	Stripping length																											
1.5 mm <sup>2</sup>	AWG 16	1.75	9 mm																											
2.5 mm <sup>2</sup>	AWG 14	2.25	9 mm																											
4 mm <sup>2</sup>	AWG 12	2.85	9.6 mm																											
6 mm <sup>2</sup>	AWG 10	3.5	9.6 mm																											
10 mm <sup>2</sup>	AWG 8	4.3	15 mm																											
					<p>Stripping length a = 15 mm for cables ≥ 5 mm Stripping length a = 18 mm for cables ≥ 6.4 mm</p>																									

\* for modules 09 14 003 3002 and 09 14 003 3102 only

Stock items in bold type

## Features

- Suitable for Han® C crimp contacts
- Designed for a high working voltage up to 830 V
- Finger safe male and female contacts
- High contact density

## Technical characteristics

Specifications DIN EN 60 664-1  
DIN EN 61 984

Approvals

### Inserts

Number of contacts	4
Electrical data acc. to EN 61 984	<b>40 A 830 V 8 kV 3</b>
Rated current	40 A
Rated voltage	830 V
Rated impulse voltage	8 kV
Pollution degree	3

Rated voltage acc. to UL	600 V
Insulation resistance	≥ 10 <sup>10</sup> Ω
Material	polycarbonate
Limiting temperatures	-40 °C ... +125 °C
Flammability acc. to UL 94	V 0
Mechanical working life - mating cycles	≥ 500

### Contacts

Material	copper alloy
Surface	- hard-silver plated
Contact resistance	3 μm Ag ≤ 0.3 mΩ
Crimp terminal	- mm <sup>2</sup> - AWG
	1.5 ... 6 mm <sup>2</sup> 16 ... 10

### Current carrying capacity

The current carrying capacity of the connectors is limited by the thermal load capability of the contact element material including the connections and the insulating parts. The derating curve is therefore valid for currents which flow constantly (non-intermittent) through each contact element of the connector evenly, without exceeding the allowed maximum temperature.

Measuring and testing techniques according to  
DIN EN 60 512-5

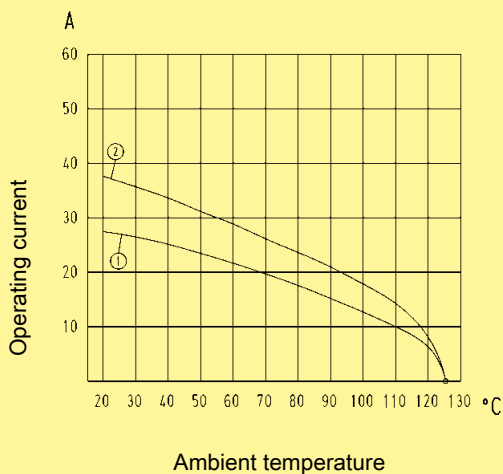

① 24 B hoods/housings with 6 modules; wire gauge: 4 mm<sup>2</sup>

② 24 B hoods/housings with 6 modules; wire gauge: 6 mm<sup>2</sup>

Number of contacts

# 4

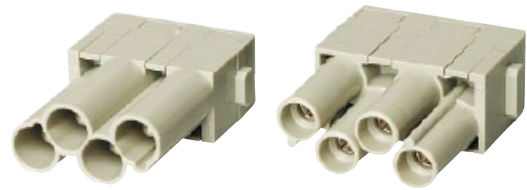

Identification	Part number		Drawing	Dimensions in mm
	Male insert (M)	Female insert (F)		
Crimp terminal Order crimp contacts separately	<b>09 14 004 3041</b>	<b>09 14 004 3141</b>		

Han Modular

Identification	Wire gauge (mm²)	Part number		Drawing	Dimensions in mm																				
		Male contact	Female contact																						
Crimp contacts Power contacts silver plated	1.5 2.5 4 6	<b>09 32 000 6104</b> <b>09 32 000 6105</b> <b>09 32 000 6107</b> <b>09 32 000 6108</b>	<b>09 32 000 6204</b> <b>09 32 000 6205</b> <b>09 32 000 6207</b> <b>09 32 000 6208</b>		<table border="1"> <thead> <tr> <th colspan="2">Wire gauge</th> <th>∅</th> <th>Stripping length</th> </tr> </thead> <tbody> <tr> <td>1.5 mm²</td> <td>AWG 16</td> <td>1.75</td> <td>9 mm</td> </tr> <tr> <td>2.5 mm²</td> <td>AWG 14</td> <td>2.25</td> <td>9 mm</td> </tr> <tr> <td>4 mm²</td> <td>AWG 12</td> <td>2.85</td> <td>9.6 mm</td> </tr> <tr> <td>6 mm²</td> <td>AWG 10</td> <td>3.5</td> <td>9.6 mm</td> </tr> </tbody> </table>	Wire gauge		∅	Stripping length	1.5 mm²	AWG 16	1.75	9 mm	2.5 mm²	AWG 14	2.25	9 mm	4 mm²	AWG 12	2.85	9.6 mm	6 mm²	AWG 10	3.5	9.6 mm
Wire gauge		∅	Stripping length																						
1.5 mm²	AWG 16	1.75	9 mm																						
2.5 mm²	AWG 14	2.25	9 mm																						
4 mm²	AWG 12	2.85	9.6 mm																						
6 mm²	AWG 10	3.5	9.6 mm																						

06  
47

Stock items in bold type

## Features

- 3 contacts (40 A) for power circuits and 4 contacts (10 A) for signal circuits
- Ideal as motor drive connector
- Male and female contacts are finger safe

## Technical characteristics

Specifications                      DIN EN 60 664-1  
     DIN EN 61 984

Approvals                             

### Inserts

Number of contacts                      3 / 4  
 Electrical data  
 acc. to EN 61 984  
 Power contacts                      **40 A 830 V 8 kV 3**  
 Rated current                              40 A  
 Rated voltage                              830 V  
 Rated impulse voltage                      8 kV  
 Pollution degree                              3

Signal contacts                              **10 A 830 V 8 kV 3**  
 Rated current                              10 A  
 Rated voltage                              830 V  
 Rated impulse voltage                      8 kV  
 Pollution degree                              3

Rated voltage  
 acc. to UL                                      600 V  
 Insulation resistance                       $\geq 10^{10} \Omega$   
 Material    polycarbonate  
 Limiting temperatures                      -40 °C ... +125 °C  
 Flammability acc. to UL 94                      V 0  
 Mechanical working life  
 - mating cycles                               $\geq 500$

### Contacts

Material    copper alloy  
 Surface  
 - hard-silver plated                              3  $\mu\text{m}$  Ag  
 - hard-gold plated                              2  $\mu\text{m}$  Au over 3  $\mu\text{m}$  Ni  
 Contact resistance  
 Power contacts                               $\leq 0.3 \text{ m}\Omega$   
 Signal contacts                               $\leq 3 \text{ m}\Omega$   
 Crimp terminal  
 -  $\text{mm}^2$   
 Power contacts                              1.5 ... 6  $\text{mm}^2$   
 Signal contacts                              0.14 ... 2.5  $\text{mm}^2$   
 - AWG  
 Power contacts                              16 ... 10  
 Signal contacts                              26 ... 14  
 Max. insulation diameter  
 - Power contacts                              5 mm

Han  
Modular

### Current carrying capacity

The current carrying capacity of the connectors is limited by the thermal load capability of the contact element material including the connections and the insulating parts. The derating curve is therefore valid for currents which flow constantly (non-intermittent) through each contact element of the connector evenly, without exceeding the allowed maximum temperature.

Measuring and testing techniques according to  
 DIN EN 60 512-5

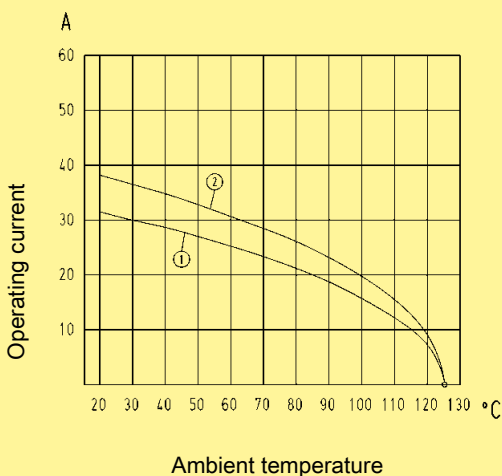

① 24 B hoods/housings with 6 modules; wire gauge: 4  $\text{mm}^2$

② 24 B hoods/housings with 6 modules; wire gauge: 6  $\text{mm}^2$

Number of contacts

3 / 4

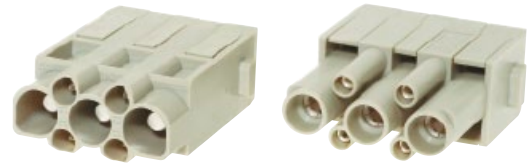

Identification	Part number		Drawing	Dimensions in mm
	Male insert (M)	Female insert (F)		
Crimp terminal Order crimp contacts separately	<b>09 14 007 3001</b>	<b>09 14 007 3101</b>		
			Contact arrangement view from termination side	

Han Modular

Identification	Wire gauge (mm²)	Part number		Drawing	Dimensions in mm																												
		Male contact	Female contact																														
Crimp contacts Power contacts																																	
silver plated	1.5 2.5 4 6	<b>09 32 000 6104</b> <b>09 32 000 6105</b> <b>09 32 000 6107</b> <b>09 32 000 6108</b>	<b>09 32 000 6204</b> <b>09 32 000 6205</b> <b>09 32 000 6207</b> <b>09 32 000 6208</b>	<table border="1"> <thead> <tr> <th colspan="2">Wire gauge</th> <th>∅</th> <th>Stripping length</th> </tr> </thead> <tbody> <tr> <td>1.5 mm²</td> <td>AWG 16</td> <td>1.75</td> <td>9 mm</td> </tr> <tr> <td>2.5 mm²</td> <td>AWG 14</td> <td>2.25</td> <td>9 mm</td> </tr> <tr> <td>4 mm²</td> <td>AWG 12</td> <td>2.85</td> <td>9.6 mm</td> </tr> <tr> <td>6 mm²</td> <td>AWG 10</td> <td>3.5</td> <td>9.6 mm</td> </tr> </tbody> </table>	Wire gauge		∅	Stripping length	1.5 mm²	AWG 16	1.75	9 mm	2.5 mm²	AWG 14	2.25	9 mm	4 mm²	AWG 12	2.85	9.6 mm	6 mm²	AWG 10	3.5	9.6 mm									
Wire gauge		∅	Stripping length																														
1.5 mm²	AWG 16	1.75	9 mm																														
2.5 mm²	AWG 14	2.25	9 mm																														
4 mm²	AWG 12	2.85	9.6 mm																														
6 mm²	AWG 10	3.5	9.6 mm																														
Signal contacts silver plated	0.14-0.37 0.5 0.75 1 1.5 2.5	<b>09 15 000 6104</b> <b>09 15 000 6103</b> <b>09 15 000 6105</b> <b>09 15 000 6102</b> <b>09 15 000 6101</b> <b>09 15 000 6106</b>	<b>09 15 000 6204</b> <b>09 15 000 6203</b> <b>09 15 000 6205</b> <b>09 15 000 6202</b> <b>09 15 000 6201</b> <b>09 15 000 6206</b>																														
gold plated	0.14-0.37 0.5 0.75 1 1.5 2.5	<b>09 15 000 6124</b> <b>09 15 000 6123</b> <b>09 15 000 6125</b> <b>09 15 000 6122</b> <b>09 15 000 6121</b> <b>09 15 000 6126</b>	<b>09 15 000 6224</b> <b>09 15 000 6223</b> <b>09 15 000 6225</b> <b>09 15 000 6222</b> <b>09 15 000 6221</b> <b>09 15 000 6226</b>	<table border="1"> <thead> <tr> <th colspan="2">Wire gauge</th> <th>∅</th> <th>Stripping length</th> </tr> </thead> <tbody> <tr> <td>0.14-0.37 mm²</td> <td>AWG 26-22</td> <td>0.9</td> <td>8 mm</td> </tr> <tr> <td>0.5 mm²</td> <td>AWG 20</td> <td>1.1</td> <td>8 mm</td> </tr> <tr> <td>0.75 mm²</td> <td>AWG 18</td> <td>1.3</td> <td>8 mm</td> </tr> <tr> <td>1 mm²</td> <td>AWG 18</td> <td>1.45</td> <td>8 mm</td> </tr> <tr> <td>1.5 mm²</td> <td>AWG 16</td> <td>1.75</td> <td>8 mm</td> </tr> <tr> <td>2.5 mm²</td> <td>AWG 14</td> <td>2.25</td> <td>6 mm</td> </tr> </tbody> </table>	Wire gauge		∅	Stripping length	0.14-0.37 mm²	AWG 26-22	0.9	8 mm	0.5 mm²	AWG 20	1.1	8 mm	0.75 mm²	AWG 18	1.3	8 mm	1 mm²	AWG 18	1.45	8 mm	1.5 mm²	AWG 16	1.75	8 mm	2.5 mm²	AWG 14	2.25	6 mm	
Wire gauge		∅	Stripping length																														
0.14-0.37 mm²	AWG 26-22	0.9	8 mm																														
0.5 mm²	AWG 20	1.1	8 mm																														
0.75 mm²	AWG 18	1.3	8 mm																														
1 mm²	AWG 18	1.45	8 mm																														
1.5 mm²	AWG 16	1.75	8 mm																														
2.5 mm²	AWG 14	2.25	6 mm																														

Stock items in bold type



Number of contacts

6

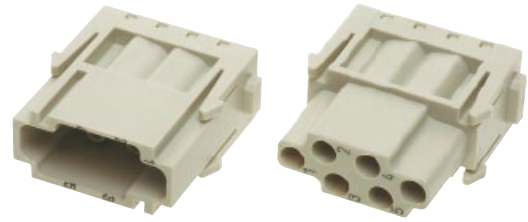

Identification	Part number		Drawing	Dimensions in mm
	Male insert (M)	Female insert (F)		
Crimp terminal Order crimp contacts separately	<b>09 14 006 3001</b>	<b>09 14 006 3101</b>	<p>Contact arrangement view from termination side</p>	

Han Modular

Identification	Wire gauge (mm²)	Part number		Drawing	Dimensions in mm
		Male contact	Female contact		
Crimp contacts Power contacts					
silver plated 	0,14-0,37	<b>09 33 000 6127</b>	<b>09 33 000 6227</b>		
	0,5	<b>09 33 000 6121</b>	<b>09 33 000 6220</b>		
	0,75	<b>09 33 000 6114</b>	<b>09 33 000 6214</b>		
	1	<b>09 33 000 6105</b>	<b>09 33 000 6205</b>		
	1,5	<b>09 33 000 6104</b>	<b>09 33 000 6204</b>		
	2,5	<b>09 33 000 6102</b>	<b>09 33 000 6202</b>		
	3	09 33 000 6106	09 33 000 6206		
	4	<b>09 33 000 6107</b>	<b>09 33 000 6207</b>		
gold plated 	0,14-0,37	09 33 000 6117	09 33 000 6217		
	0,5	<b>09 33 000 6122</b>	<b>09 33 000 6222</b>		
	0,75	<b>09 33 000 6115</b>	<b>09 33 000 6215</b>		
	1	<b>09 33 000 6118</b>	<b>09 33 000 6218</b>		
	1,5	<b>09 33 000 6116</b>	<b>09 33 000 6216</b>		
	2,5	<b>09 33 000 6123</b>	<b>09 33 000 6223</b>		
	4	09 33 000 6119	09 33 000 6221		
Relay contact silver plated 	0,75-1	09 33 000 6109			
	1,5	09 33 000 6110			
	2,5	09 33 000 6111			

Identification	Wire gauge	Stripping length
no groove	0.14-0.37 mm²	AWG 26-22
no groove	0.5 mm²	AWG 20
1 groove*	0.75 mm²	AWG 18
1 groove	1 mm²	AWG 18
2 grooves	1.5 mm²	AWG 16
3 grooves	2.5 mm²	AWG 14
wide groove	3 mm²	AWG 12
no groove	4 mm²	AWG 12

\* on the back crimp collar

Crimp contacts 0.14 ... 0.37 mm² only used with BUCHANAN crimping tool 09 99 000 0001

Stock items in bold type



Number of contacts

8

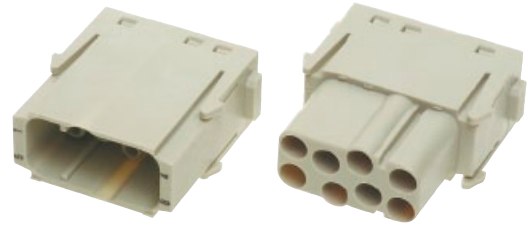

Identification	Part number		Drawing	Dimensions in mm
	Male insert (M)	Female insert (F)		
<p>Crimp terminal</p> <p>Order crimp contacts separately</p>	<b>09 14 008 3001</b>	<b>09 14 008 3101</b>	<p>                     M 34,2 14,6 34 34,2 14,6 35,8 F M F Contact arrangement view from termination side                 </p>	

Han Modular

Identification	Wire gauge (mm <sup>2</sup> )	Part number		Drawing	Dimensions in mm
		Male contact	Female contact		
<p>Crimp contacts</p> <p>Power contacts</p>				<p>Operating contact Identification</p> <p>Relay contact</p>	
<p>silver plated</p>	0.14-0.37	09 33 000 6127	09 33 000 6227		
	0.5	<b>09 33 000 6121</b>	<b>09 33 000 6220</b>		
	0.75	<b>09 33 000 6114</b>	<b>09 33 000 6214</b>		
	1	<b>09 33 000 6105</b>	<b>09 33 000 6205</b>		
	1.5	<b>09 33 000 6104</b>	<b>09 33 000 6204</b>		
	2.5	<b>09 33 000 6102</b>	<b>09 33 000 6202</b>		
	3	09 33 000 6106	09 33 000 6206		
	4	<b>09 33 000 6107</b>	<b>09 33 000 6207</b>		
<p>gold plated</p>	0.14-0.37	09 33 000 6117	09 33 000 6217		
	0.5	<b>09 33 000 6122</b>	<b>09 33 000 6222</b>		
	0.75	<b>09 33 000 6115</b>	<b>09 33 000 6215</b>		
	1	<b>09 33 000 6118</b>	<b>09 33 000 6218</b>		
	1.5	<b>09 33 000 6116</b>	<b>09 33 000 6216</b>		
	2.5	<b>09 33 000 6123</b>	<b>09 33 000 6223</b>		
	4	09 33 000 6119	09 33 000 6221		
<p>Relay contact silver plated</p>	0.75-1	09 33 000 6109			
	1.5	09 33 000 6110			
	2.5	09 33 000 6111			

Identification	Wire gauge	AWG	Stripping length
no groove	0.14-0.37 mm <sup>2</sup>	AWG 26-22	7.5 mm
no groove	0.5 mm <sup>2</sup>	AWG 20	7.5 mm
1 groove*	0.75 mm <sup>2</sup>	AWG 18	7.5 mm
1 groove	1 mm <sup>2</sup>	AWG 18	7.5 mm
2 grooves	1.5 mm <sup>2</sup>	AWG 16	7.5 mm
3 grooves	2.5 mm <sup>2</sup>	AWG 14	7.5 mm
wide groove	3 mm <sup>2</sup>	AWG 12	7.5 mm
no groove	4 mm <sup>2</sup>	AWG 12	7.5 mm

\* on the back crimp collar

Crimp contacts 0.14 ... 0.37 mm<sup>2</sup> only used with BUCHANAN crimping tool 09 99 000 0001

Stock items in bold type







Number of contacts

# 6

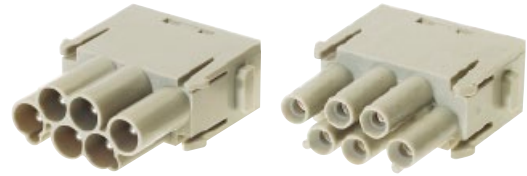

Identification	Part number		Drawing	Dimensions in mm
	Male insert (M)	Female insert (F)		
<b>Crimp terminal</b> Order crimp contacts separately	<b>09 14 006 3041</b>	<b>09 14 006 3141</b>	<p>M</p> <p>F</p> <p>M F</p> <p>Contact arrangement view from termination side</p>	

Han Modular

Identification	Wire gauge (mm²)	Part number		Drawing	Dimensions in mm
		Male contact	Female contact		
<b>Crimp contacts</b> Power contacts				<p>Operating contact Identification</p> <p>Relay contact</p>	
silver plated 	0.14-0.37	09 33 000 6127	09 33 000 6227		
	0.5	<b>09 33 000 6121</b>	<b>09 33 000 6220</b>		
	0.75	<b>09 33 000 6114</b>	<b>09 33 000 6214</b>		
	1	<b>09 33 000 6105</b>	<b>09 33 000 6205</b>		
	1.5	<b>09 33 000 6104</b>	<b>09 33 000 6204</b>		
	2.5	<b>09 33 000 6102</b>	<b>09 33 000 6202</b>		
	3	09 33 000 6106	09 33 000 6206		
	4	<b>09 33 000 6107</b>	<b>09 33 000 6207</b>		
gold plated 	0.14-0.37	09 33 000 6117	09 33 000 6217		
	0.5	<b>09 33 000 6122</b>	<b>09 33 000 6222</b>		
	0.75	<b>09 33 000 6115</b>	<b>09 33 000 6215</b>		
	1	<b>09 33 000 6118</b>	<b>09 33 000 6218</b>		
	1.5	<b>09 33 000 6116</b>	<b>09 33 000 6216</b>		
	2.5	<b>09 33 000 6123</b>	<b>09 33 000 6223</b>		
	4	09 33 000 6119	09 33 000 6221		
Relay contact silver plated 	0.75-1	09 33 000 6109			
	1.5	09 33 000 6110			
	2.5	09 33 000 6111			

Identification	Wire gauge		Stripping length
no groove	0.14-0.37 mm²	AWG 26-22	7.5 mm
no groove	0.5 mm²	AWG 20	7.5 mm
1 groove*	0.75 mm²	AWG 18	7.5 mm
1 groove	1 mm²	AWG 18	7.5 mm
2 grooves	1.5 mm²	AWG 16	7.5 mm
3 grooves	2.5 mm²	AWG 14	7.5 mm
wide groove	3 mm²	AWG 12	7.5 mm
no groove	4 mm²	AWG 12	7.5 mm

\* on the back crimp collar

Crimp contacts 0.14 ... 0.37 mm² only used with BUCHANAN crimping tool 09 99 000 0001

Stock items in bold type

## Features

- Suitable for Han E® crimp contacts
- High contact density
- Up to 16 A per contact
- Also suitable as a reliable signal connector

## Technical characteristics

Specifications DIN EN 60 664-1  
DIN EN 61 984

Approvals

### Inserts

Number of contacts	20
Electrical data acc. to EN 61 984	<b>16 A 500 V 6 kV 3</b>
Rated current	16 A
Rated voltage	500 V
Rated impulse voltage	6 kV
Pollution degree	3

Rated voltage acc. to UL	600 V
Insulation resistance	≥ 10 <sup>10</sup> Ω
Material	polycarbonate
Limiting temperatures	-40 °C ... +125 °C
Flammability acc. to UL 94	V 0
Mechanical working life - mating cycles	≥ 500

### Contacts

Material	copper alloy
Surface	- hard-silver plated - hard-gold plated
Contact resistance	3 μm Ag 2 μm Au over 3 μm Ni ≤ 1 mΩ
Crimp terminal	- mm <sup>2</sup> - AWG
	0.14 ... 4 mm <sup>2</sup> 26 ... 12

### Current carrying capacity

The current carrying capacity of the connectors is limited by the thermal load capability of the contact element material including the connections and the insulating parts. The derating curve is therefore valid for currents which flow constantly (non-intermittent) through each contact element of the connector evenly, without exceeding the allowed maximum temperature.

Measuring and testing techniques according to DIN EN 60 512-5

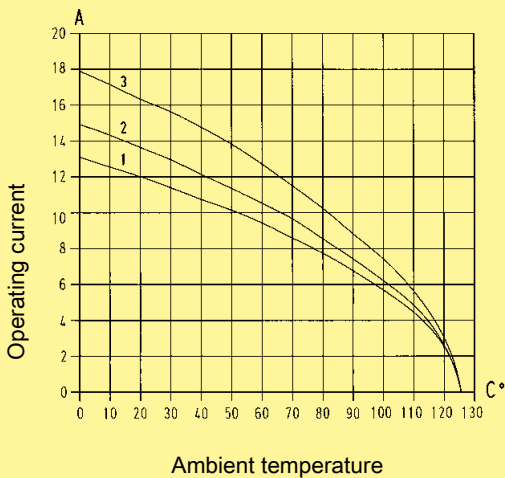

- ① 24 B hoods/housings with 3 modules; wire gauge: 1.5 mm<sup>2</sup>
- ② 24 B hoods/housings with 3 modules; wire gauge: 2.5 mm<sup>2</sup>
- ③ 24 B hoods/housings with 3 modules; wire gauge: 4 mm<sup>2</sup>

Number of contacts

20

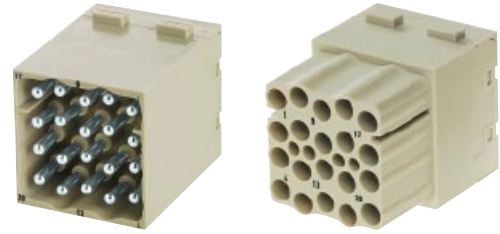

Identification	Part number		Drawing	Dimensions in mm
	Male insert (M)	Female insert (F)		
Crimp terminal Order crimp contacts separately	<b>09 14 020 3001</b>	<b>09 14 020 3101</b>	<p>Contact arrangement view from termination side</p>	

Han Modular

Identification	Wire gauge (mm <sup>2</sup> )	Part number		Drawing	Dimensions in mm
		Male contact	Female contact		
Crimp contacts Power contacts					
silver plated 	0.14-0.37	09 33 000 6127	09 33 000 6227		
	0.5	<b>09 33 000 6121</b>	<b>09 33 000 6220</b>		
	0.75	<b>09 33 000 6114</b>	<b>09 33 000 6214</b>		
	1	<b>09 33 000 6105</b>	<b>09 33 000 6205</b>		
	1.5	<b>09 33 000 6104</b>	<b>09 33 000 6204</b>		
	2.5	<b>09 33 000 6102</b>	<b>09 33 000 6202</b>		
	3	09 33 000 6106	09 33 000 6206		
	4	<b>09 33 000 6107</b>	<b>09 33 000 6207</b>		
gold plated 	0.14-0.37	09 33 000 6117	09 33 000 6217		
	0.5	<b>09 33 000 6122</b>	<b>09 33 000 6222</b>		
	0.75	<b>09 33 000 6115</b>	<b>09 33 000 6215</b>		
	1	<b>09 33 000 6118</b>	<b>09 33 000 6218</b>		
	1.5	<b>09 33 000 6116</b>	<b>09 33 000 6216</b>		
	2.5	<b>09 33 000 6123</b>	<b>09 33 000 6223</b>		
	4	09 33 000 6119	09 33 000 6221		
Relay contact silver plated 	0.75-1	09 33 000 6109			
	1.5	09 33 000 6110			
	2.5	09 33 000 6111			

Identification	Wire gauge		Stripping length
no groove	0.14-0.37 mm <sup>2</sup>	AWG 26-22	7.5 mm
no groove	0.5 mm <sup>2</sup>	AWG 20	7.5 mm
1 groove*	0.75 mm <sup>2</sup>	AWG 18	7.5 mm
1 groove	1 mm <sup>2</sup>	AWG 18	7.5 mm
2 grooves	1.5 mm <sup>2</sup>	AWG 16	7.5 mm
3 grooves	2.5 mm <sup>2</sup>	AWG 14	7.5 mm
wide groove	3 mm <sup>2</sup>	AWG 12	7.5 mm
no groove	4 mm <sup>2</sup>	AWG 12	7.5 mm

\* on the back crimp collar

## Features

- Cage-clamp terminal
- No special tools required

## Technical characteristics

Specifications DIN EN 60 664-1  
DIN EN 61 984

Approvals

### Inserts

Number of contacts 5  
 Electrical data  
 acc. to EN 61 984 **16 A 400 V 6 kV 3**  
 Rated current 16 A  
 Rated voltage 400 V  
 Rated impulse voltage 6 kV  
 Pollution degree 3

Rated voltage  
 acc. to UL 600 V  
 Insulation resistance ≥ 10<sup>10</sup> Ω  
 Material polycarbonate  
 Limiting temperatures -40 °C ... +125 °C  
 Flammability acc. to UL 94 V 0  
 Mechanical working life  
 - mating cycles ≥ 500

### Contacts

Material copper alloy  
 Surface - hard-silver plated  
 - hard-silver plated 3 μm Ag  
 Contact resistance ≤ 3 mΩ  
 Cage clamp terminal  
 - mm<sup>2</sup> 0.14 ... 2.5 mm<sup>2</sup>  
 - AWG 26 ... 14

### Current carrying capacity

The current carrying capacity of the connectors is limited by the thermal load capability of the contact element material including the connections and the insulating parts. The derating curve is therefore valid for currents which flow constantly (non-intermittent) through each contact element of the connector evenly, without exceeding the allowed maximum temperature.

Measuring and testing techniques according to DIN EN 60 512-5

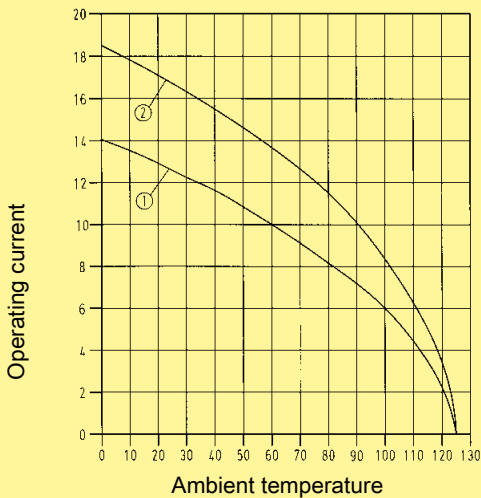

① 24 B hoods/housings with 6 modules; wire gauge: 1.5 mm<sup>2</sup>

② 24 B hoods/housings with 6 modules; wire gauge: 2.5 mm<sup>2</sup>

Number of contacts

5

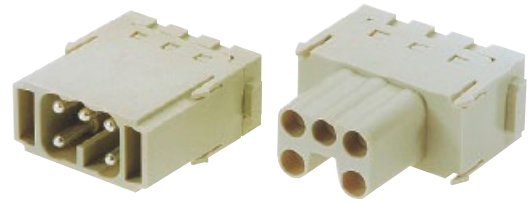

Identification	Part number		Drawing	Dimensions in mm
	Male insert (M)	Female insert (F)		
Cage-clamp terminal	<b>09 14 005 2616</b>	<b>09 14 005 2716</b>	<p>M</p> <p>F</p> <p>M F</p> <p>Contact arrangement view from termination side</p>	

Han  
Modular

## Features

- Suitable for Han E® crimp contacts
- 2 contacts up to 5000 V
- Insulator out of a voltage resistant teflon material
- Combination of all other modules (pneumatic, signal etc.)

## Technical characteristics

Specifications	DIN EN 61 984 DIN VDE 0115 DIN EN 60 664-1
----------------	--

### Inserts

Number of contacts	2
Electrical data acc. to EN 61 984	<b>16 A 2900/5000 V 15 kV 3</b>
Rated current	16 A
Rated voltage conductor - ground	2900 V
Rated voltage conductor - conductor	5000 V
Rated impulse voltage	15 kV
Pollution degree	3
Insulation resistance	≥ 10 <sup>10</sup> Ω
Material	polycarbonate/Teflon (PTFE)
Limiting temperatures	-40 °C ... +125 °C
Flammability acc. to UL 94	V 0
Mechanical working life - mating cycles	≥ 500

### Contacts

Material	copper alloy
Surface	
- hard-silver plated	3 μm Ag
- hard-gold plated	2 μm Au over 3 μm Ni
Contact resistance	≤ 1 mΩ
Crimp terminal	
- mm <sup>2</sup>	0.5 ... 4 mm <sup>2</sup>
- AWG	20 ... 12

### Current carrying capacity

The current carrying capacity of the connectors is limited by the thermal load capability of the contact element material including the connections and the insulating parts. The derating curve is therefore valid for currents which flow constantly (non-intermittent) through each contact element of the connector evenly, without exceeding the allowed maximum temperature.

Measuring and testing techniques according to DIN EN 60 512-5

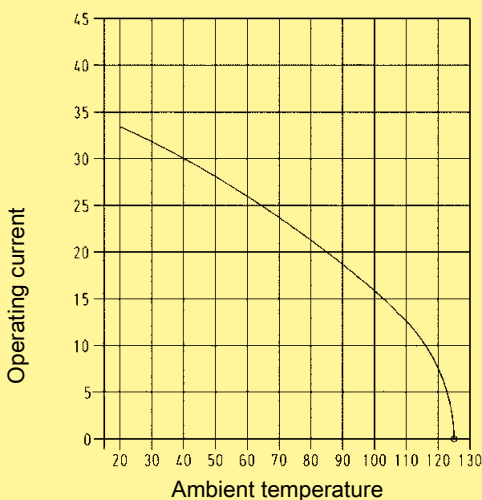

① Housing Han® 16 B with 1 Han® HV module, wire gauge: 2.5 mm<sup>2</sup>

## Assembly instructions

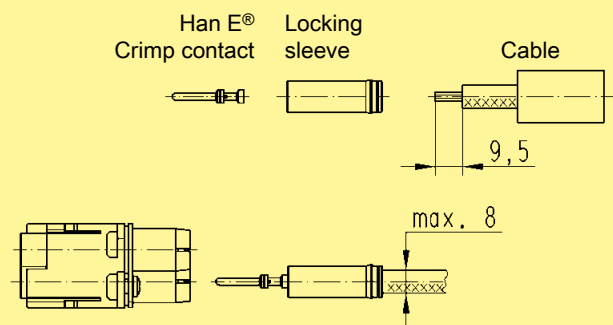

Crimp with BUCHANAN crimping tool 09 99 000 0001  
Snap crimped cable in the insert

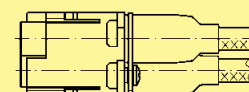

shrink the heat shrink tube over the rear of contact

Number of contacts

# 2

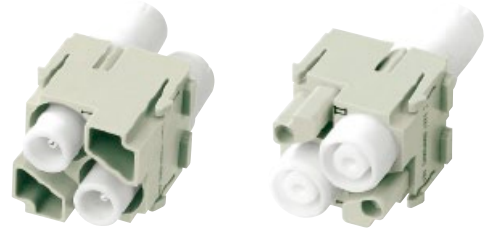

Identification	Part number		Drawing	Dimensions in mm
	Male insert (M)	Female insert (F)		
<p>Crimp terminal</p> <p>Order crimp contacts separately</p> <p>Range of delivery:</p> <ul style="list-style-type: none"> <li>- 1 module</li> <li>- 2 locking sleeves</li> <li>- 2 heat shrink tubes</li> </ul> <p>Removal tool for locking sleeve</p>	<p><b>09 14 002 3021</b></p>	<p><b>09 14 002 3121</b></p>	<p>M</p> <p>F</p> 	
	<p><b>09 99 000 0327</b></p>	<p><b>09 99 000 0327</b></p>		

Han Modular

Identification	Wire gauge (mm²)	Part number		Drawing	Dimensions in mm																																
		Male contact	Female contact																																		
<p>Crimp contacts</p> <p>silver plated</p>	<p>0.5</p> <p>0.75</p> <p>1</p> <p>1.5</p> <p>2.5</p> <p>3</p> <p>4</p>	<p><b>09 33 000 6121</b></p> <p><b>09 33 000 6114</b></p> <p><b>09 33 000 6105</b></p> <p><b>09 33 000 6104</b></p> <p><b>09 33 000 6102</b></p> <p><b>09 33 000 6106</b></p> <p><b>09 33 000 6107</b></p>	<p><b>09 33 000 6220</b></p> <p><b>09 33 000 6214</b></p> <p><b>09 33 000 6205</b></p> <p><b>09 33 000 6204</b></p> <p><b>09 33 000 6202</b></p> <p><b>09 33 000 6206</b></p> <p><b>09 33 000 6207</b></p>	<p>Operating contact Identification</p>																																	
				<table border="1"> <thead> <tr> <th>Identification</th> <th colspan="2">Wire gauge</th> <th>Stripping length</th> </tr> </thead> <tbody> <tr> <td>no groove</td> <td>0.5 mm²</td> <td>AWG 20</td> <td>9.5 mm</td> </tr> <tr> <td>1 groove*</td> <td>0.75 mm²</td> <td>AWG 18</td> <td>9.5 mm</td> </tr> <tr> <td>1 groove</td> <td>1 mm²</td> <td>AWG 18</td> <td>9.5 mm</td> </tr> <tr> <td>2 grooves</td> <td>1.5 mm²</td> <td>AWG 16</td> <td>9.5 mm</td> </tr> <tr> <td>3 grooves</td> <td>2.5 mm²</td> <td>AWG 14</td> <td>9.5 mm</td> </tr> <tr> <td>wide groove</td> <td>3 mm²</td> <td>AWG 12</td> <td>9.5 mm</td> </tr> <tr> <td>no groove</td> <td>4 mm²</td> <td>AWG 12</td> <td>9.5 mm</td> </tr> </tbody> </table> <p>* on the back crimp collar</p>	Identification	Wire gauge		Stripping length	no groove	0.5 mm²	AWG 20	9.5 mm	1 groove*	0.75 mm²	AWG 18	9.5 mm	1 groove	1 mm²	AWG 18	9.5 mm	2 grooves	1.5 mm²	AWG 16	9.5 mm	3 grooves	2.5 mm²	AWG 14	9.5 mm	wide groove	3 mm²	AWG 12	9.5 mm	no groove	4 mm²	AWG 12	9.5 mm	
Identification	Wire gauge		Stripping length																																		
no groove	0.5 mm²	AWG 20	9.5 mm																																		
1 groove*	0.75 mm²	AWG 18	9.5 mm																																		
1 groove	1 mm²	AWG 18	9.5 mm																																		
2 grooves	1.5 mm²	AWG 16	9.5 mm																																		
3 grooves	2.5 mm²	AWG 14	9.5 mm																																		
wide groove	3 mm²	AWG 12	9.5 mm																																		
no groove	4 mm²	AWG 12	9.5 mm																																		

Stock items in bold type

## Features

- Suitable for Han® C crimp contacts
- 2 contacts up to 5000 V
- Insulator out of a voltage resistant teflon material
- Combination of all other modules (pneumatic, signal etc.)

## Technical characteristics

Specifications	DIN EN 61 984 DIN VDE 0115 DIN EN 60 664-1
----------------	--

### Inserts

Number of contacts	2
Electrical data acc. to EN 61 984	<b>40 A 2900/5000 V 15 kV 3</b>
Rated current	40 A
Rated voltage conductor - ground	2900 V
Rated voltage conductor - conductor	5000 V
Rated impulse voltage	15 kV
Pollution degree	3

Insulation resistance	≥ 10 <sup>10</sup> Ω
Material	polycarbonate/Teflon (PTFE)
Limiting temperatures	-40 °C ... +125 °C
Flammability acc. to UL 94	V 0
Max. cable diameter	9 mm
Mechanical working life - mating cycles	≥ 500

### Contacts

Material	copper alloy
Surface	- hard-silver plated
Contact resistance	3 μm Ag ≤ 0.3 mΩ
Crimp terminal	- mm <sup>2</sup> - AWG
	1.5 ... 10 mm <sup>2</sup> 16 ... 8

### Current carrying capacity

The current carrying capacity of the connectors is limited by the thermal load capability of the contact element material including the connections and the insulating parts. The derating curve is therefore valid for currents which flow constantly (non-intermittent) through each contact element of the connector evenly, without exceeding the allowed maximum temperature.

Measuring and testing techniques according to DIN EN 60 512-5

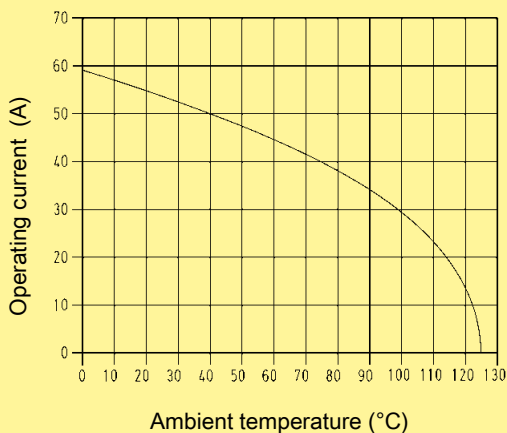

24 B hoods/housings with 3 modules; wire gauge: 6 mm<sup>2</sup>

## Assembly instructions

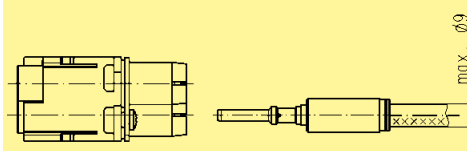
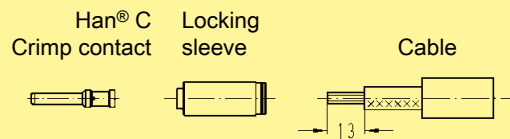

Crimp with tool 0999 000 0001, 0999 000 0110 or 0999 000 0377  
Snap crimped cable in the insert

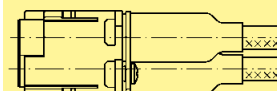

shrink the heat shrink tube over the rear of contact

Number of contacts

# 2

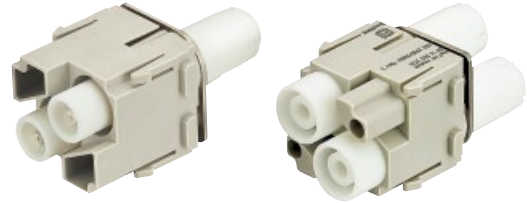

Identification	Part number		Drawing	Dimensions in mm
	Male insert (M)	Female insert (F)		
<p><b>Crimp terminal</b> Order crimp contacts separately</p> <p>Range of delivery: - 1 module - 2 locking sleeves - 2 heat shrink tubes</p> <p>Removal tool for locking sleeve</p>	<p><b>09 14 002 3023</b></p>	<p><b>09 14 002 3123</b></p>		

Han Modular

Identification	Wire gauge (mm <sup>2</sup> )	Part number		Drawing	Dimensions in mm																														
		Male contact	Female contact																																
<p><b>Crimp contacts</b></p> <p>Power contacts</p> <p>silver plated</p>	<p>1.5</p> <p>2.5</p> <p>4</p> <p>6</p> <p>10</p>	<p><b>09 32 000 6104</b></p> <p><b>09 32 000 6105</b></p> <p><b>09 32 000 6107</b></p> <p><b>09 32 000 6108</b></p> <p><b>09 32 000 6109</b></p>	<p><b>09 32 000 6204</b></p> <p><b>09 32 000 6205</b></p> <p><b>09 32 000 6207</b></p> <p><b>09 32 000 6208</b></p> <p><b>09 32 000 6209</b></p>		<table border="1"> <thead> <tr> <th colspan="3">Wire gauge</th> <th>∅</th> <th>Stripping length</th> </tr> </thead> <tbody> <tr> <td>1.5</td> <td>mm<sup>2</sup></td> <td>AWG 16</td> <td>1.75</td> <td>13 mm</td> </tr> <tr> <td>2.5</td> <td>mm<sup>2</sup></td> <td>AWG 14</td> <td>2.25</td> <td>13 mm</td> </tr> <tr> <td>4</td> <td>mm<sup>2</sup></td> <td>AWG 12</td> <td>2.85</td> <td>13 mm</td> </tr> <tr> <td>6</td> <td>mm<sup>2</sup></td> <td>AWG 10</td> <td>3.5</td> <td>13 mm</td> </tr> <tr> <td>10</td> <td>mm<sup>2</sup></td> <td>AWG 8</td> <td>4.3</td> <td>13 mm</td> </tr> </tbody> </table>	Wire gauge			∅	Stripping length	1.5	mm <sup>2</sup>	AWG 16	1.75	13 mm	2.5	mm <sup>2</sup>	AWG 14	2.25	13 mm	4	mm <sup>2</sup>	AWG 12	2.85	13 mm	6	mm <sup>2</sup>	AWG 10	3.5	13 mm	10	mm <sup>2</sup>	AWG 8	4.3	13 mm
Wire gauge			∅	Stripping length																															
1.5	mm <sup>2</sup>	AWG 16	1.75	13 mm																															
2.5	mm <sup>2</sup>	AWG 14	2.25	13 mm																															
4	mm <sup>2</sup>	AWG 12	2.85	13 mm																															
6	mm <sup>2</sup>	AWG 10	3.5	13 mm																															
10	mm <sup>2</sup>	AWG 8	4.3	13 mm																															

06  
65

Stock items in bold type

## Features

- Suitable for Han D<sup>®</sup> crimp contacts
- Standard module for power up to 10 A
- Compatible to Han DD<sup>®</sup> module with Quick Lock terminal

## Technical characteristics

Specifications                      DIN EN 60 664-1  
   DIN EN 61 984

Approvals                             

### Inserts

Number of contacts                      12  
 Electrical data  
 acc. to EN 61 984                      **10 A 250 V 4 kV 3**  
 Rated current                              10 A  
 Rated voltage                              250 V  
 Rated impulse voltage                      4 kV  
 Pollution degree                              3

Rated voltage  
 acc. to UL/CSA                              600 V  
 Insulation resistance                       $\geq 10^{10} \Omega$   
 Material                                      polycarbonate  
 Limiting temperatures                      -40 °C ... +125 °C  
 Flammability acc. to UL 94                      V 0  
 Mechanical working life  
   - mating cycles                               $\geq 500$

### Contacts

Material                                      copper alloy  
 Surface  
   - hard-silver plated                      3  $\mu\text{m}$  Ag  
   - hard-gold plated                      2  $\mu\text{m}$  Au over 3  $\mu\text{m}$  Ni  
 Contact resistance                       $\leq 3 \text{ m}\Omega$   
 Crimp terminal  
   -  $\text{mm}^2$                                       0.14 ... 2.5  $\text{mm}^2$   
   - AWG                                        26 ... 14

### Current carrying capacity

The current carrying capacity of the connectors is limited by the thermal load capability of the contact element material including the connections and the insulating parts. The derating curve is therefore valid for currents which flow constantly (non-intermittent) through each contact element of the connector evenly, without exceeding the allowed maximum temperature.

Measuring and testing techniques according to DIN EN 60 512-5

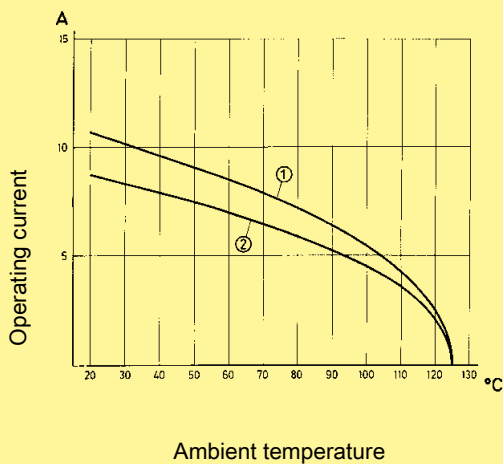

① 24 B hoods/housings with 6 modules; wire gauge: 1.5  $\text{mm}^2$

② 24 B hoods/housings with 6 modules; wire gauge: 1.0  $\text{mm}^2$

Number of contacts

12

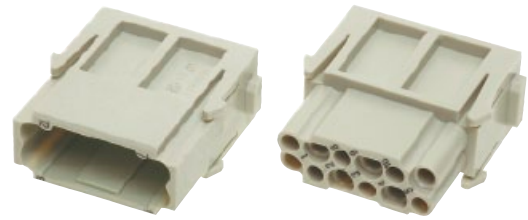

Identification	Part number		Drawing	Dimensions in mm
	Male insert (M)	Female insert (F)		
Crimp terminal Order crimp contacts separately	<b>09 14 012 3001</b>	<b>09 14 012 3101</b>	<p>M</p> <p>F</p> <p>M</p> <p>F</p> <p>Contact arrangement view from termination side</p>	

Han Modular

Identification	Wire gauge (mm <sup>2</sup> )	Part number		Drawing	Dimensions in mm																												
		Male contact	Female contact																														
Crimp contacts																																	
Power contacts																																	
silver plated	0.14-0.37	<b>09 15 000 6104</b>	<b>09 15 000 6204</b>	<table border="1"> <thead> <tr> <th colspan="2">Wire gauge</th> <th>∅</th> <th>Stripping length</th> </tr> </thead> <tbody> <tr> <td>0.14-0.37 mm<sup>2</sup></td> <td>AWG 26-22</td> <td>0.9</td> <td>8 mm</td> </tr> <tr> <td>0.5 mm<sup>2</sup></td> <td>AWG 20</td> <td>1.1</td> <td>8 mm</td> </tr> <tr> <td>0.75 mm<sup>2</sup></td> <td>AWG 18</td> <td>1.3</td> <td>8 mm</td> </tr> <tr> <td>1 mm<sup>2</sup></td> <td>AWG 18</td> <td>1.45</td> <td>8 mm</td> </tr> <tr> <td>1.5 mm<sup>2</sup></td> <td>AWG 16</td> <td>1.75</td> <td>8 mm</td> </tr> <tr> <td>2.5 mm<sup>2</sup></td> <td>AWG 14</td> <td>2.25</td> <td>6 mm</td> </tr> </tbody> </table>	Wire gauge		∅	Stripping length	0.14-0.37 mm <sup>2</sup>	AWG 26-22	0.9	8 mm	0.5 mm <sup>2</sup>	AWG 20	1.1	8 mm	0.75 mm <sup>2</sup>	AWG 18	1.3	8 mm	1 mm <sup>2</sup>	AWG 18	1.45	8 mm	1.5 mm <sup>2</sup>	AWG 16	1.75	8 mm	2.5 mm <sup>2</sup>	AWG 14	2.25	6 mm	
Wire gauge		∅	Stripping length																														
0.14-0.37 mm <sup>2</sup>	AWG 26-22	0.9	8 mm																														
0.5 mm <sup>2</sup>	AWG 20	1.1	8 mm																														
0.75 mm <sup>2</sup>	AWG 18	1.3	8 mm																														
1 mm <sup>2</sup>	AWG 18	1.45	8 mm																														
1.5 mm <sup>2</sup>	AWG 16	1.75	8 mm																														
2.5 mm <sup>2</sup>	AWG 14	2.25	6 mm																														
	0.5	<b>09 15 000 6103</b>	<b>09 15 000 6203</b>																														
	0.75	<b>09 15 000 6105</b>	<b>09 15 000 6205</b>																														
	1	<b>09 15 000 6102</b>	<b>09 15 000 6202</b>																														
	1.5	<b>09 15 000 6101</b>	<b>09 15 000 6201</b>																														
	2.5	<b>09 15 000 6106</b>	<b>09 15 000 6206</b>																														
gold plated	0.14-0.37	<b>09 15 000 6124</b>	<b>09 15 000 6224</b>																														
	0.5	<b>09 15 000 6123</b>	<b>09 15 000 6223</b>																														
	0.75	<b>09 15 000 6125</b>	<b>09 15 000 6225</b>																														
	1	<b>09 15 000 6122</b>	<b>09 15 000 6222</b>																														
	1.5	<b>09 15 000 6121</b>	<b>09 15 000 6221</b>																														
	2.5	<b>09 15 000 6126</b>	<b>09 15 000 6226</b>																														
F.O. contacts for 1 mm plastic fibre		<b>20 10 001 3211</b>	<b>20 10 001 3221</b>																														

Stock items in bold type



## Features

- Innovative Han-Quick Lock<sup>®</sup> termination technology
- Field assembly without special tools
- Mating compatible with standard Han<sup>®</sup> DD module with crimp terminal
- Reduced wiring times

## Technical characteristics

Specifications	DIN EN 60 664-1 DIN EN 61 984
----------------	----------------------------------

### Inserts

Number of contacts	12
Electrical data acc. to EN 61 984	<b>10 A 250 V 4 kV 3</b>
Rated current	10 A
Rated voltage	250 V
Rated impulse voltage	4 kV
Pollution degree	3

Insulation resistance	≥ 10 <sup>10</sup> Ω
Material	polycarbonate
Limiting temperatures	-40 °C ... +125 °C
Flammability acc. to UL 94	V 0
Mechanical working life - mating cycles	

### Contacts

Material	copper alloy
Surface	
- hard-silver plated	3 μm Ag
Contact resistance	≤ 3 mΩ
Quick Lock termination	
- mm <sup>2</sup>	0.25 ... 1.5 mm <sup>2</sup>
- AWG	22 ... 16

### Current carrying capacity

The current carrying capacity of the connectors is limited by the thermal load capability of the contact element material including the connections and the insulating parts. The derating curve is therefore valid for currents which flow constantly (non-intermittent) through each contact element of the connector evenly, without exceeding the allowed maximum temperature.

Measuring and testing techniques according to  
DIN EN 60 512-5

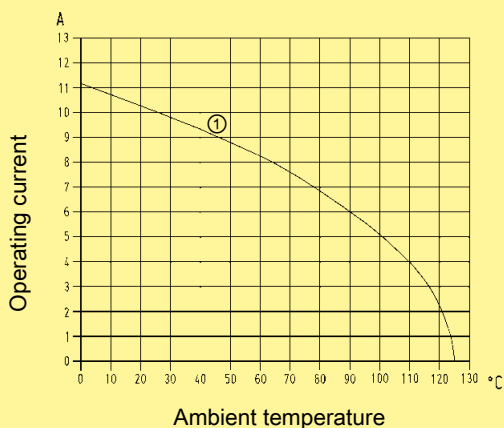

① 24 B hoods/housings with 6 modules; wire gauge: 1.5 mm<sup>2</sup>

Number of contacts

12

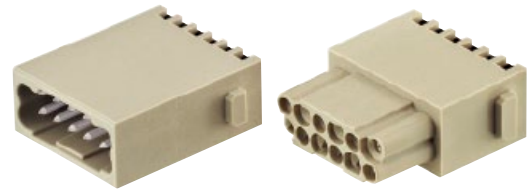

Identification	Part number		Drawing	Dimensions in mm
	Male insert (M)	Female insert (F)		
Quick Lock termination 	<b>09 14 012 2632</b>	<b>09 14 012 2732</b>		
			Contact arrangement view from termination side 	

Han Modular

## Features

- Suitable for Han D® crimp contacts
- High contact density

## Technical characteristics

Specifications DIN EN 60 664-1  
DIN EN 61 984

Approvals

### Inserts

Number of contacts	17
Electrical data acc. to EN 61 984	<b>10 A 160 V 2.5 kV 3</b>
Rated current	10 A
Rated voltage	160 V
Rated impulse voltage	2.5 kV
Pollution degree	3

Rated voltage acc. to UL	250 V
Insulation resistance	≥ 10 <sup>10</sup> Ω
Material	polycarbonate
Limiting temperatures	-40 °C ... +125 °C
Flammability acc. to UL 94	V 0
Mechanical working life - mating cycles	≥ 500

### Contacts

Material	copper alloy
Surface	
- hard-silver plated	3 μm Ag
- hard-gold plated	2 μm Au over 3 μm Ni
Contact resistance	≤ 3 mΩ
Crimp terminal	
- mm <sup>2</sup>	0.14 ... 2.5 mm <sup>2</sup>
- AWG	26 ... 14

### Current carrying capacity

The current carrying capacity of the connectors is limited by the thermal load capability of the contact element material including the connections and the insulating parts. The derating curve is therefore valid for currents which flow constantly (non-intermittent) through each contact element of the connector evenly, without exceeding the allowed maximum temperature.

Measuring and testing techniques according to DIN EN 60 512-5

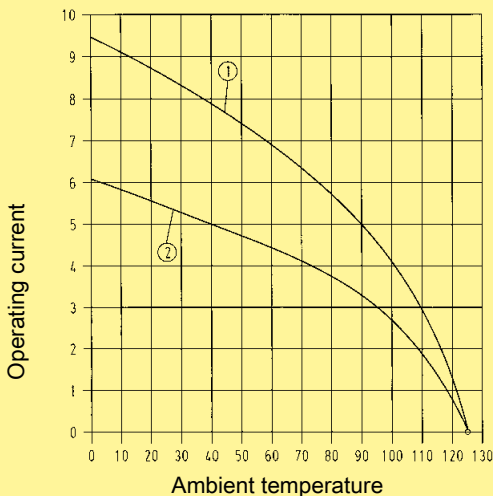

① 24 B hoods/housings with 6 modules; wire gauge: 1.5 mm<sup>2</sup>

② 24 B hoods/housings with 6 modules; wire gauge: 1.0 mm<sup>2</sup>

Number of contacts

17

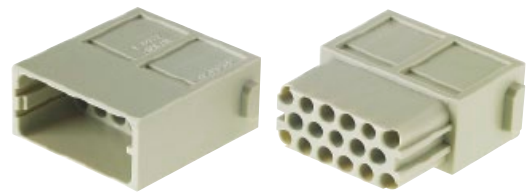

Identification	Part number		Drawing	Dimensions in mm
	Male insert (M)	Female insert (F)		
Crimp terminal Order crimp contacts separately	<b>09 14 017 3001</b>	<b>09 14 017 3101</b>	<p>Contact arrangement view from termination side</p>	

Han Modular

Identification	Wire gauge (mm <sup>2</sup> )	Part number		Drawing	Dimensions in mm																												
		Male contact	Female contact																														
Crimp contacts Power contacts silver plated 	0.14-0.37 0.5 0.75 1 1.5 2.5	<b>09 15 000 6104</b> <b>09 15 000 6103</b> <b>09 15 000 6105</b> <b>09 15 000 6102</b> <b>09 15 000 6101</b> <b>09 15 000 6106</b>	<b>09 15 000 6204</b> <b>09 15 000 6203</b> <b>09 15 000 6205</b> <b>09 15 000 6202</b> <b>09 15 000 6201</b> <b>09 15 000 6206</b>	<table border="1"> <thead> <tr> <th colspan="2">Wire gauge</th> <th>∅</th> <th>Stripping length</th> </tr> </thead> <tbody> <tr> <td>0.14-0.37 mm<sup>2</sup></td> <td>AWG 26-22</td> <td>0.9</td> <td>8 mm</td> </tr> <tr> <td>0.5 mm<sup>2</sup></td> <td>AWG 20</td> <td>1.1</td> <td>8 mm</td> </tr> <tr> <td>0.75 mm<sup>2</sup></td> <td>AWG 18</td> <td>1.3</td> <td>8 mm</td> </tr> <tr> <td>1 mm<sup>2</sup></td> <td>AWG 18</td> <td>1.45</td> <td>8 mm</td> </tr> <tr> <td>1.5 mm<sup>2</sup></td> <td>AWG 16</td> <td>1.75</td> <td>8 mm</td> </tr> <tr> <td>2.5 mm<sup>2</sup></td> <td>AWG 14</td> <td>2.25</td> <td>6 mm</td> </tr> </tbody> </table>	Wire gauge		∅	Stripping length	0.14-0.37 mm <sup>2</sup>	AWG 26-22	0.9	8 mm	0.5 mm <sup>2</sup>	AWG 20	1.1	8 mm	0.75 mm <sup>2</sup>	AWG 18	1.3	8 mm	1 mm <sup>2</sup>	AWG 18	1.45	8 mm	1.5 mm <sup>2</sup>	AWG 16	1.75	8 mm	2.5 mm <sup>2</sup>	AWG 14	2.25	6 mm	
Wire gauge		∅	Stripping length																														
0.14-0.37 mm <sup>2</sup>	AWG 26-22	0.9	8 mm																														
0.5 mm <sup>2</sup>	AWG 20	1.1	8 mm																														
0.75 mm <sup>2</sup>	AWG 18	1.3	8 mm																														
1 mm <sup>2</sup>	AWG 18	1.45	8 mm																														
1.5 mm <sup>2</sup>	AWG 16	1.75	8 mm																														
2.5 mm <sup>2</sup>	AWG 14	2.25	6 mm																														
F.O. contacts for 1 mm plastic fibre 		<b>20 10 001 3211</b>	<b>20 10 001 3221</b>																														

Stock items in bold type

## Features

- Suitable for D-Sub crimp contacts
- High contact density
- Using of guiding pins (male and female) is recommended (see chapter 40).

## Technical characteristics

Specifications                      DIN EN 60 664-1  
     DIN EN 61 984

Approvals                             

### Inserts

Number of contacts                      25  
 Electrical data  
 acc. to EN 61 984                      **4 A 50 V 0.8 kV 3**  
 Rated current                              4 A  
 Rated voltage                              50 V  
 Rated impulse voltage                    0.8 kV  
 Pollution degree                          3

Rated voltage  
 acc. to UL                                  < 30 V  
 Insulation resistance                      ≥ 10<sup>10</sup> Ω  
 Material                                      polycarbonate  
 Limiting temperatures                    -40 °C ... +125 °C  
 Flammability acc. to UL 94              V 0  
 Mechanical working life  
   - mating cycles                          ≥ 500

### Contacts

Crimp terminal  
   - mm<sup>2</sup>                                      0.08 ... 0.52 mm<sup>2</sup>  
   - AWG                                      28 ... 20  
 turned contacts                          Performance level 1  
     as per CECC 75 301-802,  
     500 mating cycles,  
     10 days 4 mixed gas test -  
     IEC 60 512

### Current carrying capacity

The current carrying capacity of the connectors is limited by the thermal load capability of the contact element material including the connections and the insulating parts. The derating curve is therefore valid for currents which flow constantly (non-intermittent) through each contact element of the connector evenly, without exceeding the allowed maximum temperature.

Measuring and testing techniques according to  
 DIN EN 60 512-5

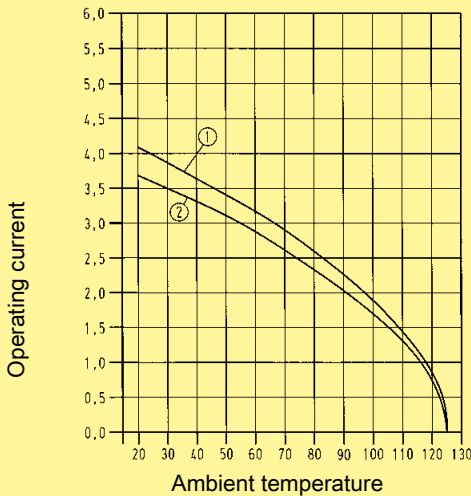

① 24 B hoods/housings with 6 modules; wire gauge: 0.5 mm<sup>2</sup> turned contacts

② 24 B hoods/housings with 6 modules; wire gauge: 0.5 mm<sup>2</sup> stamped contacts

Number of contacts

# 25

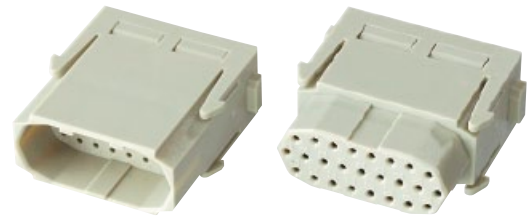

Identification	Part number		Drawing	Dimensions in mm
	Male insert (M)	Female insert (F)		
Crimp terminal Order crimp contacts separately	<b>09 14 025 3001</b>	<b>09 14 025 3101</b>	<p>                         M                          F                          M                          F                          Contact arrangement view from termination side                     </p>	

Han Modular

Identification	Wire gauge (mm²)	Part number		Drawing	Dimensions in mm												
		Male contact	Female contact														
D-Sub crimp contacts 	0.08-0.21 0.13-0.33 0.21-0.52	<b>09 67 000 7576</b> <b>09 67 000 5576</b> <b>09 67 000 8576</b>	<b>09 67 000 7476</b> <b>09 67 000 5476</b> <b>09 67 000 8476</b>	<table border="1"> <thead> <tr> <th colspan="2">Wire gauge</th> <th rowspan="2">Stripping length</th> </tr> </thead> <tbody> <tr> <td>0.08-0.21 mm²</td> <td>AWG 28-24</td> <td>4 mm</td> </tr> <tr> <td>0.13-0.33 mm²</td> <td>AWG 26-22</td> <td>4 mm</td> </tr> <tr> <td>0.21-0.52 mm²</td> <td>AWG 24-20</td> <td>4 mm</td> </tr> </tbody> </table>	Wire gauge		Stripping length	0.08-0.21 mm²	AWG 28-24	4 mm	0.13-0.33 mm²	AWG 26-22	4 mm	0.21-0.52 mm²	AWG 24-20	4 mm	
Wire gauge		Stripping length															
0.08-0.21 mm²	AWG 28-24		4 mm														
0.13-0.33 mm²	AWG 26-22	4 mm															
0.21-0.52 mm²	AWG 24-20	4 mm															
Insertion / Removal tool for D-Sub crimp contacts 		<b>09 99 000 0368</b>	<b>09 99 000 0368</b>														

## Features

- 9-pin D-Sub connector of the Han-Modular® system
- Ideal for the transmission of sensitive signals
- Compatible to crimp, solder or IDC termination
- Using of guiding pins (male and female) is recommended (see chapter 40).

## Technical characteristics

Specifications                    DIN EN 60 664-1  
     DIN EN 61 984

Approvals                            





### Inserts

Number of contacts	9
Electrical data acc. to EN 61 984	<b>5 A 50 V 0.8 kV 3</b>
Rated current	5 A
Rated voltage	50 V
Rated impulse voltage	0.8 kV
Pollution degree	3
Rated voltage acc. to UL	< 30 V
Insulation resistance	≥ 10 <sup>10</sup> Ω
Material	polycarbonate
Limiting temperatures	-40 °C ... +125 °C
Flammability acc. to UL 94	V 0
Mechanical working life - mating cycles	≥ 500

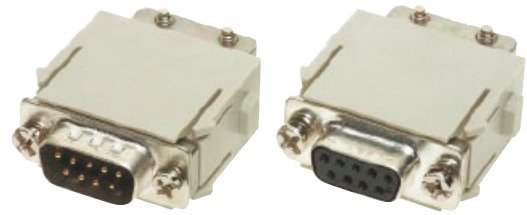
Number of contacts

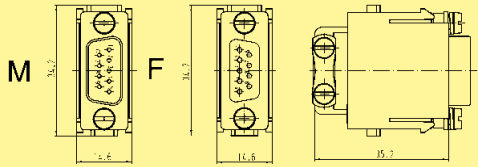
# 9

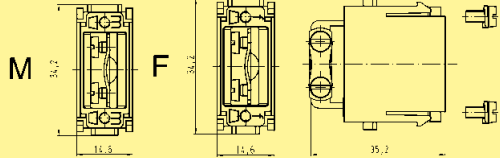

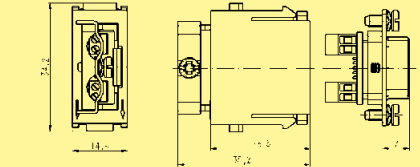
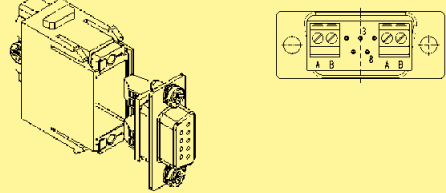
Identification	Part number		Drawing	Dimensions in mm						
	Male insert (M)	Female insert (F)								
<p><b>Crimp terminal</b> Order crimp contacts separately (see page 06.65)</p> 	<b>09 14 009 3001</b>	<b>09 14 009 3101</b>								
<p><b>Adapter module without D-Sub insert</b></p> <p>for one cable</p>  <p>for two cables</p>	<b>09 14 000 9930</b>	<b>09 14 000 9931</b>								
<p><b>Screw terminal</b> for RS 485-based bus systems with T-functionality</p> 		<b>09 14 009 3151</b>	  <p>Contact arrangement view from termination side</p> <table border="1" data-bbox="1034 1854 1375 1966"> <thead> <tr> <th>Signal</th> <th>Contact no.</th> </tr> </thead> <tbody> <tr> <td>A</td> <td>8</td> </tr> <tr> <td>B</td> <td>3</td> </tr> </tbody> </table>	Signal	Contact no.	A	8	B	3	
Signal	Contact no.									
A	8									
B	3									







Han Modular

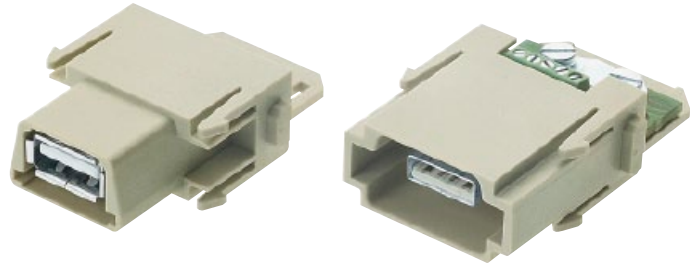

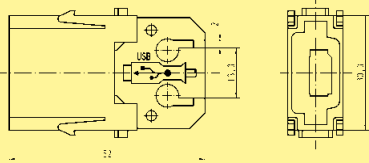
Number of contacts

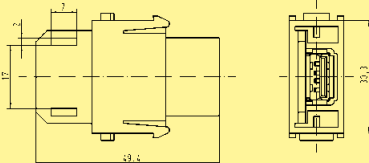
# 4

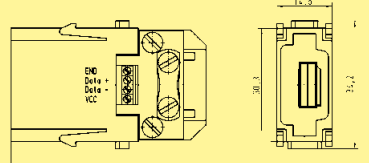

Identification	Part number		Drawing	Dimensions in mm
	Male insert (M)	Female insert (F)		
Module for patch cable Male insert  	<b>09 14 001 4601</b>			
Module for patch cable Female insert  		<b>09 14 001 4701</b>		
Module for screw termination Male insert  	<b>09 14 001 4651</b>			
Patch cable USB male / male Style A  	2 m <b>39 50 903 0050</b>  5 m <b>39 50 903 0051</b>	2 m <b>39 50 903 0050</b>  5 m <b>39 50 903 0051</b>		



Han  
Modular

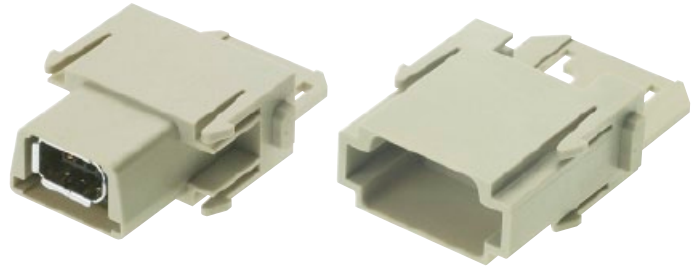

Number of contacts

# 6

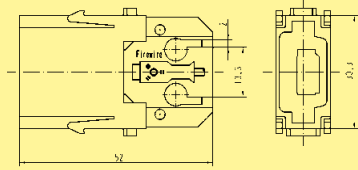

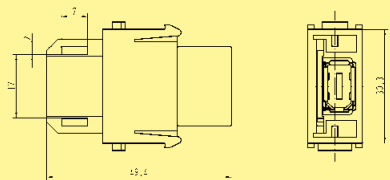
Identification	Part number		Drawing	Dimensions in mm
	Male insert (M)	Female insert (F)		
Module for patch cable Male insert  	<b>09 14 001 4611</b>			
Module for patch cable Female insert  		<b>09 14 001 4711</b>		

Han  
Modular

## Features

- Single module with standard shielded RJ45 plug and jack
- Cat 6 for all data pairs (all 8 pins)
- Conforming to the RoHS directive
- The RJ45 inserts are protected by a reliable plastic insulator
- Patch cables are assembled/removed without tools

## Technical characteristics

Specifications                    DIN EN 60 664-1  
     DIN EN 61 984

Approvals                         





### Inserts

Number of contacts	8
Electrical data acc. to EN 61 984	<b>1 A 50 V 0.8 kV 3</b>
Rated current	1 A
Rated voltage	50 V
Rated impulse voltage	0.8 kV
Pollution degree	3
Rated voltage acc. to UL	< 30 V
Transmission features	Category 6 / Class E up to 250 MHz; acc. to ISO/IEC 11 801:2002 and EN 50 173-1
Transmission rate	10/100/1000 Mbit/s
Insulation resistance	≥ 10 <sup>10</sup> Ω
Material	polycarbonate
Limiting temperatures	-40 °C ... +85 °C
Flammability acc. to UL 94	V 0
Mechanical working life - mating cycles	≥ 500

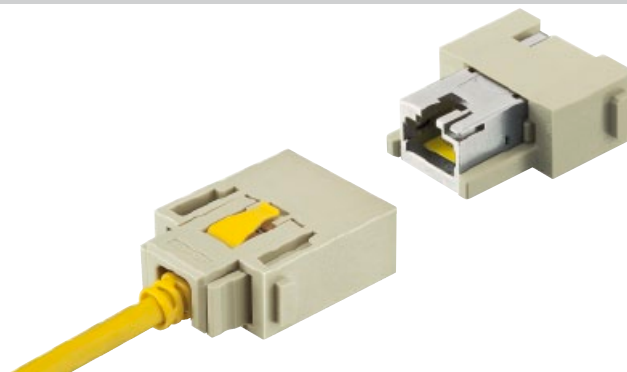
Number of contacts

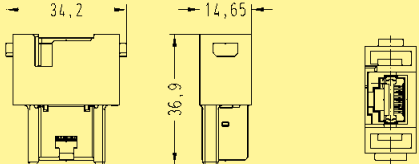
# 8

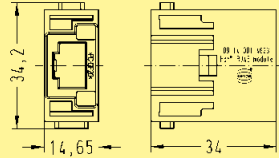

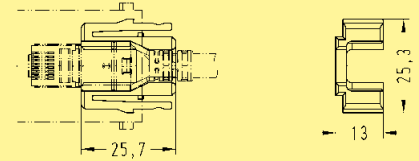
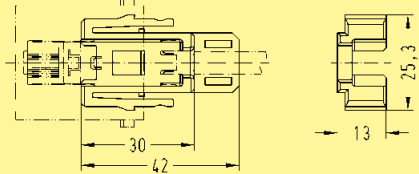
Identification	Part number		Drawing	Dimensions in mm
	Male insert (M)	Female insert (F)		
Gender Changer for patch cable 		<b>09 14 001 4721</b>		
Male insert 	<b>09 14 001 4623</b>			
Adapter for HARTING patch cable 	<b>09 14 000 9966</b>			
Adapter for HARTING RJ Industrial® see page 06.85				

Han  
Modular

## Features

- Locking lever protection for RJ45 connector latch
- Very short plug design in combination with robust bend protection
- RoHS compliant
- Fully EMC screened (aluminium-clad foil and braid)

## Technical characteristics

Specifications	ISO/IEC 24 702 ISO/IEC 11 801 ISO/IEC 61 935-2
----------------	--

### Cat. 5 e RJ45 patch cable

Transmission features	Category 5 / Class D up to 100 MHz; acc. to ISO/IEC 24 702 or ISO/IEC 11 801
Transmission rate	10/100/1000 Mbit/s
Cable type	1:1 EIA/TIA 568 B, 8 poles
Material cables	SF/UTP, PUR, yellow
Limiting temperatures	
- mobile	0 °C ... +60 °C
- stationary	-40 °C ... +80 °C
Flammability	flame retardant, halogen-free
Degree of protection	IP 20

### Cat. 6 RJ45 patch cable

Transmission features	Category 6 / Class E up to 250 MHz; acc. to ISO/IEC 24 702 or ISO/IEC 11 801
Transmission rate	10/100/1000 Mbit/s
Cable type	1:1 EIA/TIA 568 B, 8 poles
Material cables	SF/UTP, PUR, yellow
Limiting temperatures	
- mobile	0 °C ... +60 °C
- stationary	-20 °C ... +80 °C
Flammability	flame retardant, halogen-free
Degree of protection	IP 20

Number of contacts

8



Identification

Part number

Drawing

Dimensions in mm

Cat. 5e RJ45 patch cable

Length	Part number
0.2 m	<b>09 47 474 7001</b>
0.3 m	<b>09 47 474 7002</b>
0.4 m	<b>09 47 474 7003</b>
0.5 m	<b>09 47 474 7004</b>
0.6 m	<b>09 47 474 7005</b>
0.7 m	<b>09 47 474 7006</b>
0.8 m	<b>09 47 474 7007</b>
0.9 m	<b>09 47 474 7008</b>
1.0 m	<b>09 47 474 7009</b>
1.5 m	<b>09 47 474 7010</b>
2.0 m	<b>09 47 474 7011</b>
2.5 m	<b>09 47 474 7012</b>
3.0 m	<b>09 47 474 7013</b>
4.0 m	<b>09 47 474 7014</b>
5.0 m	<b>09 47 474 7015</b>
6.0 m	<b>09 47 474 7016</b>
7.0 m	<b>09 47 474 7017</b>
7.5 m	<b>09 47 474 7018</b>
8.0 m	<b>09 47 474 7019</b>
9.0 m	<b>09 47 474 7020</b>
10 m	<b>09 47 474 7021</b>
15 m	<b>09 47 474 7022</b>
20 m	<b>09 47 474 7023</b>

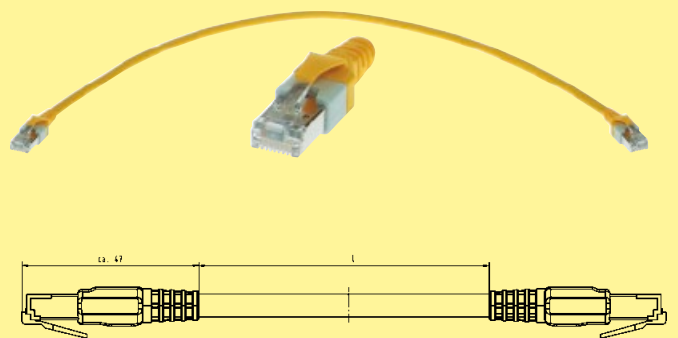

Han Modular

Cat. 6 RJ45 patch cable

Length	Part number
0.2 m	<b>09 47 474 7101</b>
0.3 m	<b>09 47 474 7102</b>
0.4 m	<b>09 47 474 7103</b>
0.5 m	<b>09 47 474 7104</b>
0.6 m	<b>09 47 474 7105</b>
0.7 m	<b>09 47 474 7106</b>
0.8 m	<b>09 47 474 7107</b>
0.9 m	<b>09 47 474 7108</b>
1.0 m	<b>09 47 474 7109</b>
1.5 m	<b>09 47 474 7110</b>
2.0 m	<b>09 47 474 7111</b>
2.5 m	<b>09 47 474 7112</b>
3.0 m	<b>09 47 474 7113</b>
4.0 m	<b>09 47 474 7114</b>
5.0 m	<b>09 47 474 7115</b>
6.0 m	<b>09 47 474 7116</b>
7.0 m	<b>09 47 474 7117</b>
7.5 m	<b>09 47 474 7118</b>
8.0 m	<b>09 47 474 7119</b>
9.0 m	<b>09 47 474 7120</b>
10 m	<b>09 47 474 7121</b>
15 m	<b>09 47 474 7122</b>
20 m	<b>09 47 474 7123</b>

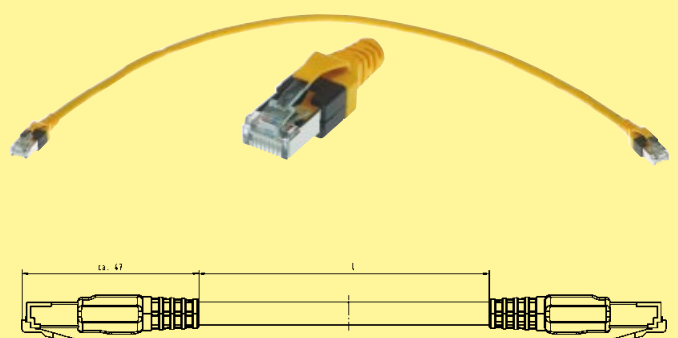

## Features

### Han-Modular® RJ Industrial RJ45 connector set

- Conforming to the RoHS directive
- 360° shielded contact
- Field assembly without tools possible by means of HARAX® rapid termination in IDC technology
- Suitable for termination of massive and flexible wires

### Han-Modular® RJ Industrial Gigalink RJ45 connector set

- Conforming to the RoHS directive
- 360° shielded contact
- Field assembly by means of piercing contacts
- Suitable for termination of flexible wires

Han  
Modular

## Technical characteristics

Specifications	IEC 60 603-7 DIN EN 60 664-1 DIN EN 61 984
----------------	--

### HARTING RJ Industrial®, 4 pins

Number of contacts	4
Transmission features	Category 5 / Class D up to 100 MHz; acc. to ISO/IEC 11 801:2002 and EN 50 173-1
Transmission rate	10/100 Mbit/s
Wire termination	IDC contacts; without tools
Terminated cable	
- Conductor cross section	
flexible	AWG 24/7 ... AWG 22/7
solid	AWG 23/1 ... AWG 22/1
- Cable outside diameter	≤ 1.6 mm
Material insert	polyamide
Limiting temperatures	-40 °C ... +70 °C

### HARTING RJ Industrial® Gigalink, 8 pins

Number of contacts	8
Transmission features	Category 6 / Class E up to 250 MHz; acc. to ISO/IEC 11 801:2002 and EN 50 173-1
Transmission rate	10/100/1000 Mbit/s
Wire termination	Piercing contacts
Terminated cable	
- Conductor cross section	
flexible	AWG 28/7 ... AWG 24/7
- Cable outside diameter	≤ 1.05 mm
Material insert	polyamide
Limiting temperatures	-40 °C ... +70 °C



### HARTING RJ Industrial® 10G, 8 pins

Number of contacts	8
Transmission features	Category 6 / Class E up to 250 MHz; acc. to ISO/IEC 11 801:2002 and EN 50 173-1
Transmission rate	10/100/1000 Mbit/s
Wire termination	IDC contacts; without tools
Terminated cable	
- Conductor cross section	
flexible	AWG 27/7 ... AWG 22/7
solid	AWG 27/1 ... AWG 22/1
- Cable outside diameter	≤ 1.5 mm
Material insert	polyamide
Limiting temperatures	-40 °C ... +70 °C

Number of contacts

4 / 8

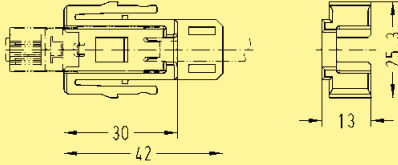

Identification	Part number Male insert (M)	Drawing	Dimensions in mm
<p>Han-Modular® RJ Industrial RJ45 connector set</p>  <p>Cat. 5 4 pins for AWG 24 ... 22 4 pins for AWG 26</p> <p>Cat. 6 Gigalink, 8 pins Gigalink, 8 pins</p> <p>Cat. 6 10G, 8 pins</p>	<p><b>09 45 400 1100</b> <b>09 45 400 1109</b></p> <p><b>09 45 400 1500</b> <b>09 45 400 1510</b></p> <p><b>09 45 400 1560</b></p>		<p>Set consists of the relevant RJ45 insert and the suitable adapter for Han® RJ45 male module (please order the male module 09 14 001 4623 separately)</p>
<p>HARTING RJ Industrial® Gigalink Assembly tool</p>	<p><b>09 45 800 0500</b></p>		

Han  
Modular

\* usable with male insert 09 14 001 4623 (see page 06.81)

Stock items in bold type

## Features

- Shielding bus separate from housing potential
- Ideal for the transmission of sensitive signals (e.g. bus signals)
- Usable for Gigabit Ethernet Cat. 6

## Technical characteristics

Specifications                      DIN EN 60 664-1  
DIN EN 61 984

Approvals                              

### Inserts

Number of contacts	8
Insulation resistance	$\geq 10^{10} \Omega$
Material	polycarbonate
Limiting temperatures	-40 °C ... +125 °C
Flammability acc. to UL 94	V 0
Mechanical working life	
- mating cycles	$\geq 500$

### GigaBit contacts

Number of contacts	8 + shielding
Electrical data	
acc. to EN 61 984	<b>5 A 50 V 0.8 kV 3</b>
Rated current	5 A
Rated voltage	50 V
Rated impulse voltage	0.8 kV
Pollution degree	3
Rated voltage	
acc. to UL	< 30 V

Material	
- Insulator	polycarbonate
- Outer conductor	zinc alloy
Contact resistance	$\leq 4 \text{ m}\Omega$
Limiting temperatures	-40 °C ... +85 °C
Flammability acc. to UL 94	V 0
Outer surface finish	nickel
Cable diameter	5 ... 12 mm

### D-Sub crimp contacts

Crimp terminal	
- mm <sup>2</sup>	0.08 ... 0.52 mm <sup>2</sup>
- AWG	28 ... 20
turned contacts	Performance level 1

Number of contacts

# 8

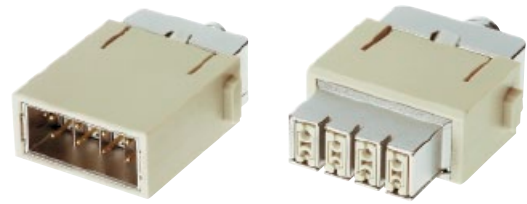

Identification	Part number		Drawing	Dimensions in mm
	Male insert (M)	Female insert (F)		
Han® GigaBit module  	<b>09 14 001 3011</b>	<b>09 14 001 3111</b>		

Han Modular

Identification	Wire gauge (mm²)	Part number		Drawing	Dimensions in mm												
		Male contact	Female contact														
GigaBit contacts 8 + shielding Order crimp contacts separately    D-Sub crimp contacts  	0,08-0,21 0,13-0,33 0,21-0,52	<b>09 14 008 3011</b>   09 67 000 7576 <b>09 67 000 5576</b> <b>09 67 000 8576</b>	<b>09 14 008 3111</b>   09 67 000 7476 <b>09 67 000 5476</b> <b>09 67 000 8476</b>		<table border="1"> <thead> <tr> <th colspan="2">Wire gauge</th> <th>Stripping length</th> </tr> </thead> <tbody> <tr> <td>0,08-0,21 mm²</td> <td>AWG 28-24</td> <td>4 mm</td> </tr> <tr> <td>0,13-0,33 mm²</td> <td>AWG 26-22</td> <td>4 mm</td> </tr> <tr> <td>0,21-0,52 mm²</td> <td>AWG 24-20</td> <td>4 mm</td> </tr> </tbody> </table>	Wire gauge		Stripping length	0,08-0,21 mm²	AWG 28-24	4 mm	0,13-0,33 mm²	AWG 26-22	4 mm	0,21-0,52 mm²	AWG 24-20	4 mm
Wire gauge		Stripping length															
0,08-0,21 mm²	AWG 28-24	4 mm															
0,13-0,33 mm²	AWG 26-22	4 mm															
0,21-0,52 mm²	AWG 24-20	4 mm															

06  
87

Stock items in bold type

Han  
Modular

Identification	Part number	Drawing	Dimensions in mm																																				
<p>Crimp flange</p> <table border="0"> <tr> <td>D1</td> <td>D2</td> </tr> <tr> <td>3.0</td> <td>4.0</td> </tr> <tr> <td>3.5</td> <td>4.5</td> </tr> <tr> <td>4.0</td> <td>5.0</td> </tr> <tr> <td>4.5</td> <td>5.5</td> </tr> <tr> <td>5.0</td> <td>6.0</td> </tr> <tr> <td>5.5</td> <td>6.5</td> </tr> <tr> <td>6.0</td> <td>7.0</td> </tr> <tr> <td>6.5</td> <td>7.5</td> </tr> <tr> <td>7.0</td> <td>8.0</td> </tr> <tr> <td>7.5</td> <td>8.5</td> </tr> <tr> <td>8.0</td> <td>9.0</td> </tr> <tr> <td>8.5</td> <td>9.5</td> </tr> <tr> <td>9.0</td> <td>10.0</td> </tr> </table>	D1	D2	3.0	4.0	3.5	4.5	4.0	5.0	4.5	5.5	5.0	6.0	5.5	6.5	6.0	7.0	6.5	7.5	7.0	8.0	7.5	8.5	8.0	9.0	8.5	9.5	9.0	10.0	<p>61 03 000 0062  <b>61 03 000 0063</b>  <b>61 03 000 0064</b>          61 03 000 0065          61 03 000 0066          61 03 000 0166  <b>61 03 000 0067</b>  <b>61 03 000 0068</b>  <b>61 03 000 0069</b>          61 03 000 0070          61 03 000 0071          61 03 000 0165          61 03 000 0072</p>										
D1	D2																																						
3.0	4.0																																						
3.5	4.5																																						
4.0	5.0																																						
4.5	5.5																																						
5.0	6.0																																						
5.5	6.5																																						
6.0	7.0																																						
6.5	7.5																																						
7.0	8.0																																						
7.5	8.5																																						
8.0	9.0																																						
8.5	9.5																																						
9.0	10.0																																						
<p>Crimp ferrule</p> <table border="0"> <tr> <td>D3</td> <td>D4</td> </tr> <tr> <td>5.0</td> <td>6.0</td> </tr> <tr> <td>5.5</td> <td>6.5</td> </tr> <tr> <td>6.0</td> <td>7.0</td> </tr> <tr> <td>6.5</td> <td>7.5</td> </tr> <tr> <td>7.0</td> <td>8.0</td> </tr> <tr> <td>7.5</td> <td>8.5</td> </tr> <tr> <td>8.0</td> <td>9.0</td> </tr> <tr> <td>8.5</td> <td>9.5</td> </tr> <tr> <td>9.0</td> <td>10.0</td> </tr> <tr> <td>9.5</td> <td>10.5</td> </tr> <tr> <td>10.0</td> <td>11.0</td> </tr> <tr> <td>10.5</td> <td>11.5</td> </tr> <tr> <td>11.0</td> <td>12.0</td> </tr> <tr> <td>11.5</td> <td>12.5</td> </tr> <tr> <td>12.0</td> <td>13.0</td> </tr> <tr> <td>12.5</td> <td>13.5</td> </tr> <tr> <td>13.0</td> <td>14.0</td> </tr> </table>	D3	D4	5.0	6.0	5.5	6.5	6.0	7.0	6.5	7.5	7.0	8.0	7.5	8.5	8.0	9.0	8.5	9.5	9.0	10.0	9.5	10.5	10.0	11.0	10.5	11.5	11.0	12.0	11.5	12.5	12.0	13.0	12.5	13.5	13.0	14.0	<p>61 03 000 0045          61 03 000 0046  <b>61 03 000 0047</b>          61 03 000 0048  <b>61 03 000 0049</b>  <b>61 03 000 0050</b>          61 03 000 0051  <b>61 03 000 0052</b>          61 03 000 0053  <b>61 03 000 0054</b>  <b>61 03 000 0055</b>          61 03 000 0056  <b>61 03 000 0057</b>  <b>61 03 000 0058</b>          61 03 000 0142          61 03 000 0059          61 03 000 0127</p>		
D3	D4																																						
5.0	6.0																																						
5.5	6.5																																						
6.0	7.0																																						
6.5	7.5																																						
7.0	8.0																																						
7.5	8.5																																						
8.0	9.0																																						
8.5	9.5																																						
9.0	10.0																																						
9.5	10.5																																						
10.0	11.0																																						
10.5	11.5																																						
11.0	12.0																																						
11.5	12.5																																						
12.0	13.0																																						
12.5	13.5																																						
13.0	14.0																																						
<p>Cable clamp</p> <p>cable diameter approx. 5 ... 7 mm          cable diameter approx. 7 ... 10 mm          cable diameter approx. 10 ... 12 mm</p>	<p><b>61 03 000 0141</b>  <b>61 03 000 0044</b>  <b>61 03 000 0143</b></p>																																						

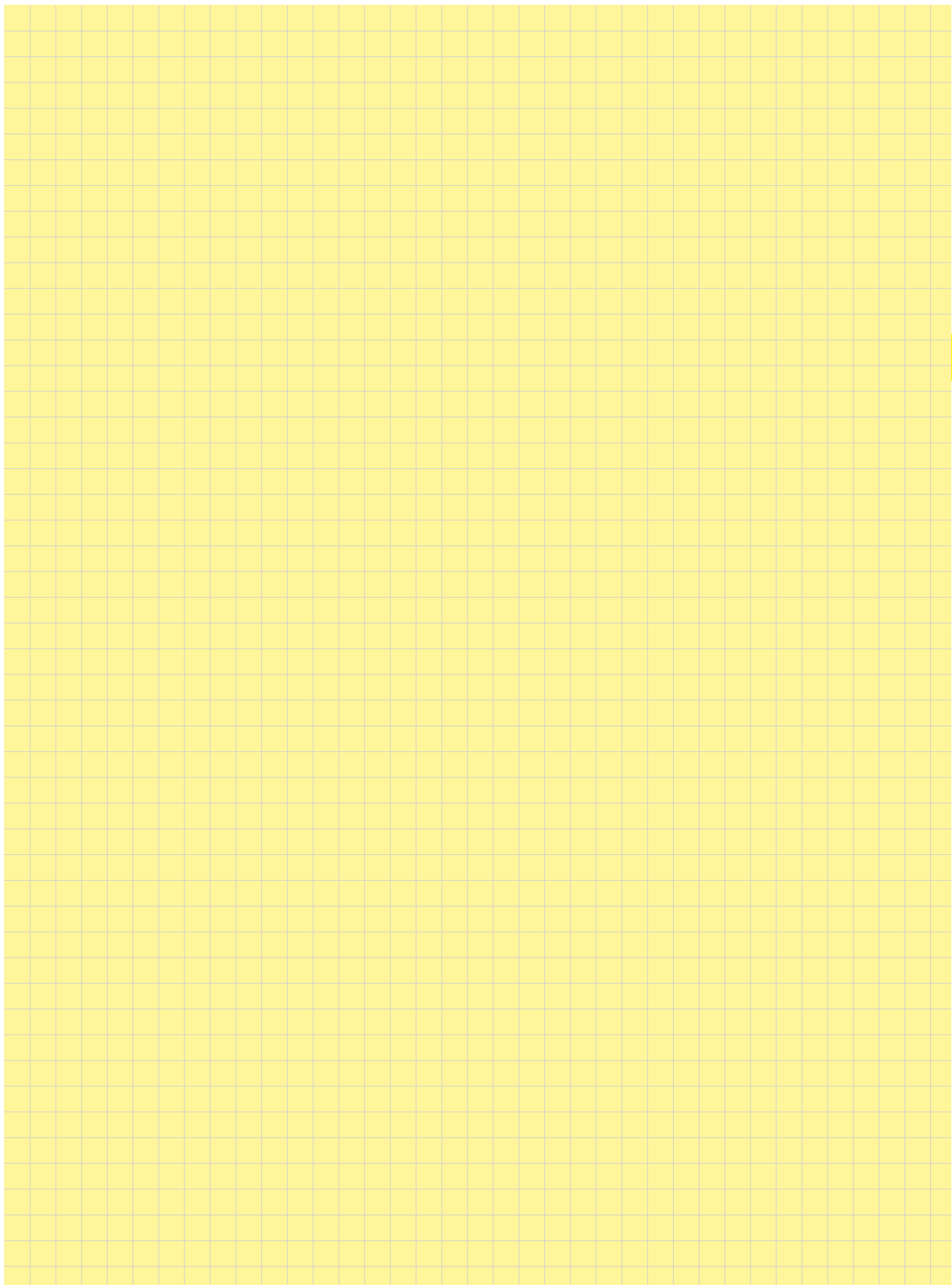



Number of contacts

# 2

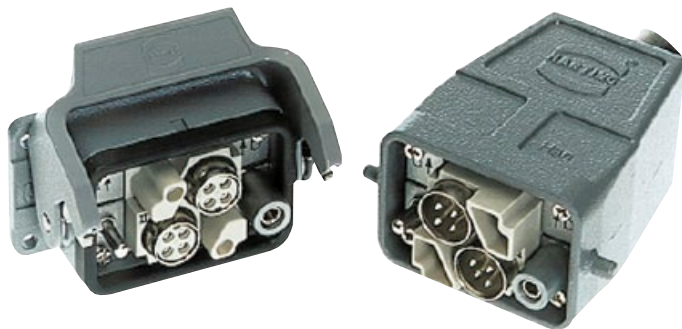

Identification	Part number		Drawing	Dimensions in mm
	Male insert (M)	Female insert (F)		
<p>Crimp terminal</p>	<b>09 14 002 3001</b>	<b>09 14 002 3101</b>	<p>M</p> <p>F</p> <p>Contact arrangement view from termination side</p>	
<p>Quintax metal adapter option</p>	<b>09 14 000 9915</b>	<b>09 14 000 9915</b>		

Han Modular

Identification	Wire gauge (mm <sup>2</sup> )	Part number		Drawing	Dimensions in mm												
		Male contact	Female contact														
<p>Quintax contact 4 + shielding Han D® crimp contacts</p>		<b>09 15 004 3013</b>	<b>09 15 004 3113</b>														
<p>Han D® Crimp contact gold plated</p>	0.14-0.37 0.5 0.75 1 1.5 2.5	<b>09 15 000 6124</b> <b>09 15 000 6123</b> <b>09 15 000 6125</b> <b>09 15 000 6122</b> <b>09 15 000 6121</b> <b>09 15 000 6126</b>	<b>09 15 000 6224</b> <b>09 15 000 6223</b> <b>09 15 000 6225</b> <b>09 15 000 6222</b> <b>09 15 000 6221</b> <b>09 15 000 6226</b>														
<p>High Density Quintax contact 8 + shielding Han® D-Sub contacts</p>		<b>09 15 008 3013</b>	<b>09 15 008 3113</b>														
<p>D-Sub crimp contact</p>	0.08-0.21 0.13-0.33 0.21-0.52	<b>09 67 000 7576</b> <b>09 67 000 5576</b> <b>09 67 000 8576</b>	<b>09 67 000 7476</b> <b>09 67 000 5476</b> <b>09 67 000 8476</b>	<table border="1"> <thead> <tr> <th colspan="2">Wire gauge</th> <th>Stripping length</th> </tr> </thead> <tbody> <tr> <td>0,08-0,21 mm<sup>2</sup></td> <td>AWG 28-24</td> <td>4 mm</td> </tr> <tr> <td>0,13-0,33 mm<sup>2</sup></td> <td>AWG 26-22</td> <td>4 mm</td> </tr> <tr> <td>0,21-0,52 mm<sup>2</sup></td> <td>AWG 24-20</td> <td>4 mm</td> </tr> </tbody> </table>	Wire gauge		Stripping length	0,08-0,21 mm <sup>2</sup>	AWG 28-24	4 mm	0,13-0,33 mm <sup>2</sup>	AWG 26-22	4 mm	0,21-0,52 mm <sup>2</sup>	AWG 24-20	4 mm	
Wire gauge		Stripping length															
0,08-0,21 mm <sup>2</sup>	AWG 28-24	4 mm															
0,13-0,33 mm <sup>2</sup>	AWG 26-22	4 mm															
0,21-0,52 mm <sup>2</sup>	AWG 24-20	4 mm															

Order crimp contacts separately

Stock items in bold type

## Features

- Well known Quintax concept
- Suitable for contacts with large diameters
- Han E® coax is applicable to the ETCS Eurobalise cable

## RF transmission characteristics

### Impedance 75 Ω

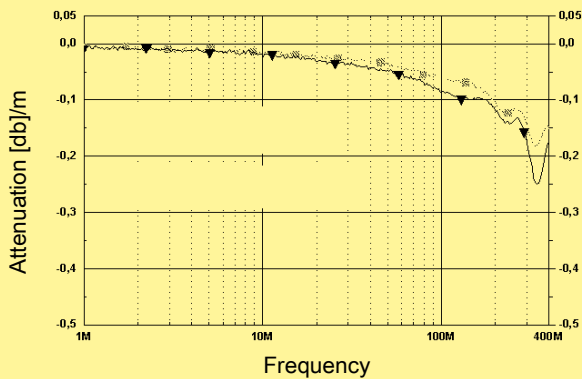

- 75 Ω cable
- 75 Ω cable with Han D® Coax
- 75 Ω coax cable diameter shielding: 7.3 mm

### Impedance 50 Ω

Han E® Coax with ETCS S21 Eurobalise cable (4 mm <sup>2</sup> )	<b>27 MHz</b>
Return loss [db]	35.4
Attenuation [db]	0.017

Han E® Coax with RG 213 cable (2.5 mm <sup>2</sup> )	<b>200 MHz</b>	<b>500 MHz</b>	<b>1.0 GHz</b>	<b>1.2 GHz</b>	<b>1.5 GHz</b>	<b>2.0 GHz</b>	<b>2.5 GHz</b>
Return loss [db]	23.8	21.1	>18.7	>17.7	>16.4	>14.1	>12.0
Attenuation [db]	0.07	0.11	0.17	0.2	<0.23	<0.53	<2.0

## Technical characteristics

Specifications DIN EN 60 664-1  
DIN EN 61 984

Approvals

### Inserts

Number of contacts 2  
Insulation resistance  $\geq 10^{10} \Omega$   
Material polycarbonate  
Limiting temperatures  $-40^\circ\text{C} \dots +125^\circ\text{C}$   
Flammability acc. to UL 94 V 0  
Mechanical working life  
- mating cycles  $\geq 500$

### Coax contacts

Number of contacts 1 + shielding  
Electrical data acc. to EN 61 984  
- Han D® Coax **10 A 50 V 0.8 kV 3**  
- Han E® Coax **16 A 50 V 0.8 kV 3**  
Rated current 10 A / 16 A  
Rated voltage 50 V  
Rated impulse voltage 0.8 kV  
Pollution degree 3  
Impedance  
- Han D® Coax 75 Ω  
- Han E® Coax 50 Ω  
Material  
- Insulator polycarbonate  
- Outer conductor zinc alloy  
Contact resistance  $\leq 4 \text{ m}\Omega$   
Limiting temperatures  $-40^\circ\text{C} \dots +85^\circ\text{C}$   
Flammability acc. to UL 94 V 0  
Outer surface finish nickel  
Cable diameter 3 ... 9.5 mm

### Han D® contacts

Material copper alloy  
Surface  
- hard-gold plated  $2 \mu\text{m Au over } 3 \mu\text{m Ni}$   
Contact resistance  $\leq 3 \text{ m}\Omega$   
Crimp terminal  
- mm<sup>2</sup> 0.14 ... 2.5 mm<sup>2</sup>  
- AWG 26 ... 14

### Han E® contacts



Material copper alloy  
Surface  
- hard-gold plated  $2 \mu\text{m Au over } 3 \mu\text{m Ni}$   
Contact resistance  $\leq 1 \text{ m}\Omega$   
Crimp terminal  
- mm<sup>2</sup> 0.14 ... 5.5 mm<sup>2</sup>  
- AWG 26 ... 10

Number of contacts

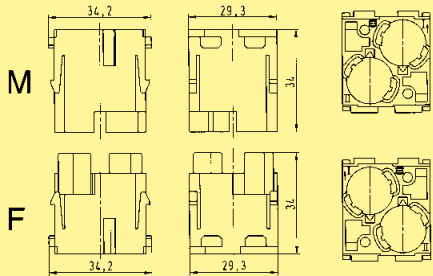
# 2

Identification	Part number		Drawing	Dimensions in mm
	Male insert (M)	Female insert (F)		
<p>Crimp terminal</p> 	<b>09 14 002 3001</b>	<b>09 14 002 3101</b>	 <p>M</p> <p>F</p> <p>Contact arrangement view from termination side</p>	

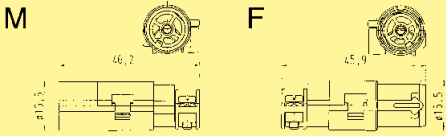
Han Modular

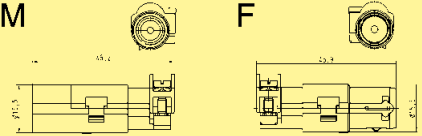
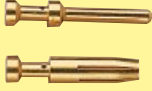
Identification	Wire gauge (mm <sup>2</sup> )	Part number		Drawing	Dimensions in mm
		Male contact	Female contact		
<p>Han® D Coax contact 1 + shielding, 75 Ω Han D® crimp contacts</p> 		<b>09 15 001 3013</b>	<b>09 15 001 3113</b>	 <p>M</p> <p>F</p>	
<p>Han D® Crimp contact gold plated</p> 	0.14-0.37 0.5 0.75 1 1.5 2.5	<b>09 15 000 6124</b> <b>09 15 000 6123</b> <b>09 15 000 6125</b> <b>09 15 000 6122</b> <b>09 15 000 6121</b> <b>09 15 000 6126</b>	<b>09 15 000 6224</b> <b>09 15 000 6223</b> <b>09 15 000 6225</b> <b>09 15 000 6222</b> <b>09 15 000 6221</b> <b>09 15 000 6226</b>		
<p>Han® E Coax contact 1 + shielding, 50 Ω Han E® crimp contacts</p> 		<b>09 15 001 3023</b>	<b>09 15 001 3123</b>	 <p>M</p> <p>F</p>	
<p>Han E® contacts gold plated</p> 	0.14-0.37 0.5 0.75 1 1.5 2.5 4 5.5	<b>09 33 000 6117</b> <b>09 33 000 6122</b> <b>09 33 000 6115</b> <b>09 33 000 6118</b> <b>09 33 000 6116</b> <b>09 33 000 6123</b> <b>09 33 000 6119</b> <b>09 33 000 6139</b>	<b>09 33 000 6217</b> <b>09 33 000 6222</b> <b>09 33 000 6215</b> <b>09 33 000 6218</b> <b>09 33 000 6216</b> <b>09 33 000 6223</b> <b>09 33 000 6221</b> <b>09 33 000 6239</b>		

Order crimp contacts separately

Stock items in bold type

## Features

- Suitable for FOC and coaxial contacts acc. to DIN 41 626
- Using of guiding pins (male and female) is imperative (see chapter 40).

### Contact arrangement

according to following matrix

Contacts	Male insert (M) 09 14 004 4501	Female insert (F) 09 14 004 4512
Coaxial contacts	09 14 000 62xx	09 14 000 61xx
F.O. contacts	20 10 xxx 421x	20 10 xxx 422x

### Coaxial cables (group 2)

Wires	Shell ∅	Internal wire ∅	Attenuation db/100 m at		
			100 MHz	200 MHz	800 MHz
<b>50 Ω</b>					
RG 174 / U	2.5	0.48			84
RG 188 A / U	2.6	0.54	29	40	
RG 316 / U	2.5	0.54		40	
<b>75 Ω</b>					
RG 179 B / U	2.55	0.3		41	
RG 187 A / U	2.7	0.3		41	

## Technical characteristics

Specifications DIN EN 60 664-1  
DIN EN 61 984

Approvals

### Inserts

Number of contacts 4  
 Insulation resistance  $\geq 10^{10} \Omega$   
 Material polycarbonate  
 Limiting temperatures  $-40 \text{ °C} \dots +125 \text{ °C}$   
 Flammability acc. to UL 94 V 0  
 Mechanical working life  
 - mating cycles  $\geq 500$

### Contacts

#### Coaxial contacts

Material copper alloy  
 Surface  
 - hard-gold plated demand level 2  
 Impedance  $50 \Omega / 75 \Omega$   
 Contact resistance  
 - Internal wire  $\leq 10 \text{ m}\Omega$   
 - Outer conductor  $\leq 3 \text{ m}\Omega$   
 Rated current 1.5 A  
 Rated voltage 50 V

#### F.O. contacts

Fibre type Glas fibre (GI)  
 Attenuation  $< 1.5 \text{ dB}$

#### F.O. contacts

Fibre type Polymer Optical Fibre (POF)  
 Attenuation  $< 2.5 \text{ dB}$

## Assembly instructions

Stripping de-  
scription

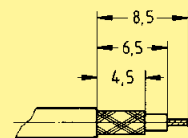

Assembly details  
for coaxial contacts

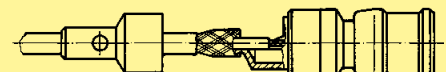

Crimp barrel solder

Solder temperature approx.  $300 \text{ °C}$   
 Solder duration approx. 2 s

Due to the closed entry design of female insert the upper part has to be removed by screw driver (7 mm) before extracting the contacts. In this case the module will be destroyed.

Number of contacts

# 4

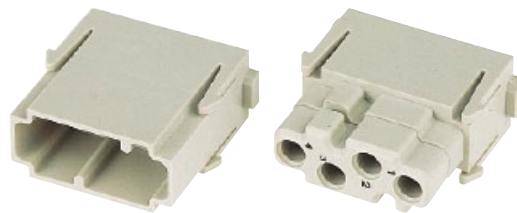

Identification	Part number		Drawing	Dimensions in mm
	Male insert (M)	Female insert (F)		
Multi module acc. to DIN 41 626 Order contacts separately	<b>09 14 004 4501</b>	<b>09 14 004 4512</b>	<p>Contact arrangement view from termination side</p>	

Han  
Modular

Identification	Impedance	Part number		Drawing	Dimensions in mm
Coaxial contacts acc. to DIN 41 626* Solder / crimp contact 	50 Ω 75 Ω	<b>09 14 000 6211</b> <b>09 14 000 6221</b>	<b>09 14 000 6111</b> <b>09 14 000 6121</b>	<p>For cable group 2 flexible wires</p>	
F.O. contacts acc. to DIN 41 626 for SI fibre (HCS®) 200/230 μm  for GI fibre 50/125 μm or 62.5/125 μm ceramic ferrule  for 1 mm plastic fibre 		<b>20 10 230 4211</b>	<b>20 10 230 4221</b>		

\* Using of guiding pins is imperative (see chapter 40).

Stock items in bold type



Number of contacts

# 4

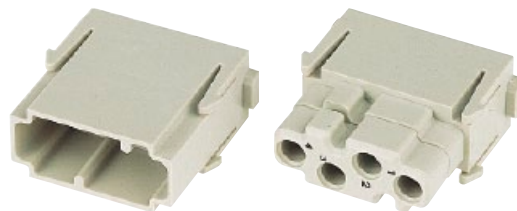

Identification	Part number		Drawing	Dimensions in mm
	Male insert (M)	Female insert (F)		
Multi module acc. to D-Sub Order contacts separately	<b>09 14 004 4501</b>	<b>09 14 004 4513*</b>	<p>M</p> <p>F</p> <p>Contact arrangement view from termination side</p>	

Han  
Modular

Identification	Impedance	Part number		Drawing	Dimensions in mm
Coaxial contacts acc. to D-Sub Performance level 2 Solder / solder contact	50 Ω	<b>09 14 000 6215</b>	<b>09 14 000 6115</b>		RG 58
Solder / crimp contact Performance level S4		50 Ω 09 69 281 5140 09 69 181 5140 50 Ω 09 69 281 5141 09 69 181 5141 50 Ω 09 69 281 5143 09 69 181 5143 75 Ω 09 69 281 5230 09 69 181 5230	RG 174 U, 188 AU, 316 U RG 178 BU, 196 AU, 404 U RG 58 CU, 141 AU RG 179 BU, 187 AU		
Crimp / crimp terminal Performance level S4		50 Ω 09 69 282 5140 09 69 182 5140 75 Ω 09 69 282 5230 09 69 182 5230	RG 174 U, 188 AU, 316 U RG 179 BU, 187 AU		

\* Due to the closed entry design of female insert the upper part has to be removed by screw driver (7 mm) before extracting the contacts. In this case the module will be destroyed.

**Stock items in bold type**

## Features

- Suitable for FOC and coaxial contacts acc. to DIN 41 626
- Using of guiding pins (male and female) is imperative (see chapter 40).

### Contact arrangement

according to following matrix

Contacts	Male insert (M) 09 14 004 4501	Female insert (F) 09 14 004 4512
Coaxial contacts	09 14 000 62xx	09 14 000 61xx
F.O. contacts	20 10 xxx 421x	20 10 xxx 422x

### Coaxial cables (group 2)

Wires	Shell ∅ mm	Internal wire ∅ mm	Attenuation db/100 m at		
			100 MHz	200 MHz	800 MHz
<b>50 Ω</b>					
RG 174 / U	2.5	0.48	29	40	84
RG 188 A / U	2.6	0.54			
RG 316 / U	2.5	0.54			
<b>75 Ω</b>					
RG 179 B / U	2.55	0.3	41	41	
RG 187 A / U	2.7	0.3			

## Technical characteristics

Specifications                      DIN EN 60 664-1  
  DIN EN 61 984

### Inserts

Number of contacts                      12  
 Insulation resistance                     $\geq 10^{10} \Omega$   
 Material                                      polycarbonate  
 Limiting temperatures                    -40 °C ... +125 °C  
 Flammability acc. to UL 94              V 0  
 Mechanical working life  
   - mating cycles                             $\geq 500$

### Contacts

#### Coaxial contacts

Material                                      copper alloy  
 Surface  
   - hard-gold plated                        demand level 2  
 Impedance                                 50 Ω / 75 Ω  
 Contact resistance  
   - Internal wire                             $\leq 10 \text{ m}\Omega$   
   - Outer conductor                         $\leq 3 \text{ m}\Omega$   
 Rated current                               1.5 A  
 Rated voltage                               50 V

#### F.O. contacts

Fibre type                                    glas fibre (GI)  
 Attenuation                                 < 1.5 dB

#### F.O. contacts

Fibre type                                    polymer Optical Fibre (POF)  
 Attenuation                                 < 2.5 dB

## Assembly instructions

### Stripping de- scription

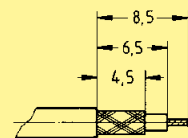

### Assembly details for coaxial contacts

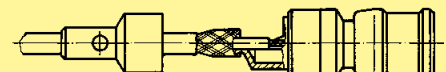

Crimp barrel                      solder

Solder temperature                      approx. 300 °C  
 Solder duration                            approx. 2 s

Due to the closed entry design of female insert the upper part has to be removed by screw driver before extracting the contacts.

Number of contacts

# 4

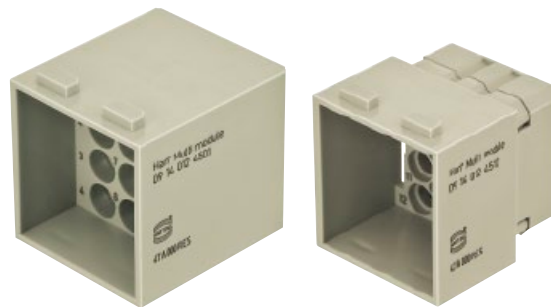

Identification	Part number		Drawing	Dimensions in mm
	Male insert (M)	Female insert (F)		
Multi module acc. to DIN 41 626 Order contacts separately	09 14 012 4501	09 14 012 4512		Contact arrangement view termination side 

Han  
Modular

Identification	Impedance	Part number		Drawing	Dimensions in mm
Coaxial contacts acc. to DIN 41 626* Solder / crimp contact 	50 Ω 75 Ω	09 14 000 6211 09 14 000 6221	09 14 000 6111 09 14 000 6121		For cable group 2 flexible wires
F.O. contacts acc. to DIN 41 626* for SI fibre (HCS®) 200/230 μm  for GI fibre 50/125 μm or 62.5/125 μm ceramic ferrule  for 1 mm plastic fibre 		20 10 230 4211	20 10 230 4221		

\* Usage of guiding pins is imperative (see chapter 40).

## Features

- For the transmission of clean and dry compressed
- Female contacts with / without shut off
- Removal of tubes from pre-assembled pneumatic contacts is possible

### Shut off principle:

In the disconnected position the spring integrated in the female contact is active, thus the O-ring of the valve seals the opening of the air-way. During the mating process, when the defined depth of insertion is reached the male contact presses on the valve head and moves it backwards against the spring tension, so that the air-way opens.

Using of guiding pins in connection with pneumatic modules is imperative.

In addition to this guiding pins guarantee a coding, if pneumatic modules are used exclusively.

## Technical characteristics

Approvals 

### Inserts \*

Number of contacts	2
Colour	blue
Material	polycarbonate
Limiting temperatures	-40 °C ... +80 °C
Flammability acc. to UL 94	V 0
Mechanical working life - mating cycles	≥ 500

### Contacts

Material	delrin acetal
Colour	black
Tube termination - Internal diameter (ID)	6.0 mm / 1/4"
Working pressure	up to 8 bar / 116 psi

### Sealing

Material	Buna-N
----------	--------

### Shut off valve

Material	Polypropylen
----------	--------------

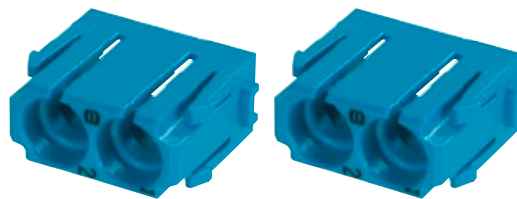

Number of contacts

# 2

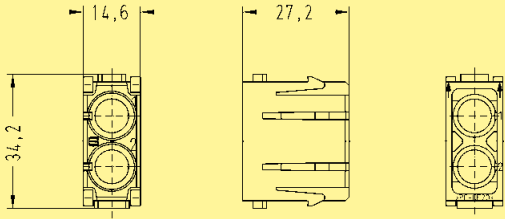

Identification	Part number		Drawing	Dimensions in mm
	Male insert (M)	Female insert (F)		
for 6 mm Order contacts separately 	<b>09 14 002 4501*</b>	<b>09 14 002 4501*</b>	 <p>Contact arrangement view from termination side</p>	

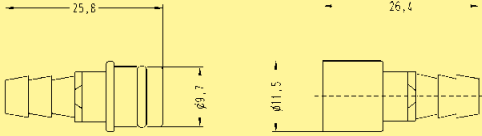
Han Modular

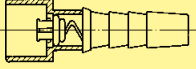
Identification	ID (mm)	Part number		Drawing	Dimensions in mm
		Male contact	Female contact		
Pneumatic contacts without shut off for tube internal diameter (ID) 	6.0	<b>09 14 000 6174</b>	<b>09 14 000 6274</b>	 <p>Male contact                      Female contact</p>	
Pneumatic contacts with shut off for tube internal diameter (ID) 	6.0		<b>09 14 000 6279</b>	 <p>female contact with shut off in closed position</p>	

\* Using of guiding pins is imperative (see chapter 40).

Stock items in bold type

## Features

- For the transmission of clean and dry compressed
- Female contacts with / without shut off
- Removal of tubes from pre-assembled pneumatic contacts is possible

### Shut off principle:

In the disconnected position the spring integrated in the female contact is active, thus the O-ring of the valve seals the opening of the air-way. During the mating process, when the defined depth of insertion is reached the male contact presses on the valve head and moves it backwards against the spring tension, so that the air-way opens.

Using of guiding pins in connection with pneumatic modules is imperative.

In addition to this guiding pins guarantee a coding, if pneumatic modules are used exclusively.

## Technical characteristics

Approvals 

### Inserts \*

Number of contacts	3
Colour	blue
Material	polycarbonate
Limiting temperatures	-40 °C ... +80 °C
Flammability acc. to UL 94	V 0
Mechanical working life - mating cycles	≥ 500

### Contacts

Material	delrin acetal
Colour	black
Tube termination	
- Internal diameter (ID)	1.6 mm / 1/16" 3.0 mm 4.0 mm / 1/8"
Working pressure	up to 8 bar / 116 psi

### Sealing

Material	Buna-N
----------	--------

### Shut off valve

Material	Polypropylen
----------	--------------

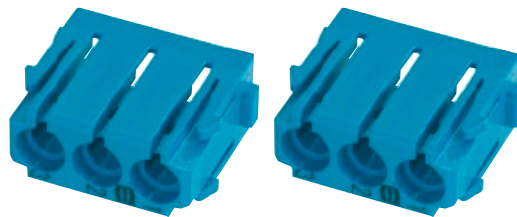

Number of contacts

# 3

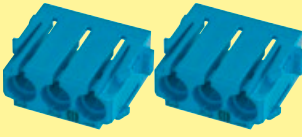
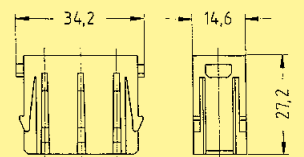

Identification	Part number		Drawing	Dimensions in mm
	Male insert (M)	Female insert (F)		
for 1.6; 3; 4 mm Order contacts separately 	<b>09 14 003 4501*</b>	<b>09 14 003 4501*</b>	 <p>Contact arrangement view from termination side</p>	

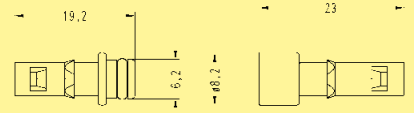
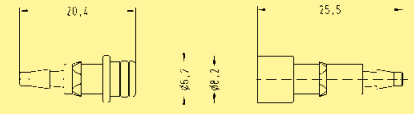
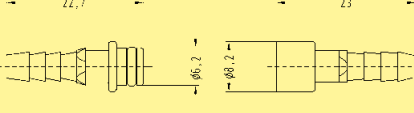
Han Modular

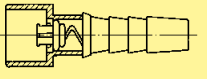
Identification	ID (mm)	Part number		Drawing	Dimensions in mm
		Male contact	Female contact		
Pneumatic contacts without shut off for tube internal diameter (ID) 	1.6	<b>09 14 000 6151</b>	<b>09 14 000 6251</b>		
	3.0	<b>09 14 000 6152</b>	<b>09 14 000 6252</b>		
	4.0	<b>09 14 000 6153</b>	<b>09 14 000 6253</b>		
Pneumatic contacts with shut off for tube internal diameter (ID) 	1.6 3.0 4.0		<b>09 14 000 6256</b> <b>09 14 000 6257</b> <b>09 14 000 6258</b>	 <p>female contact with shut off in closed position</p>	

\* Using of guiding pins is imperative (see chapter 40).

Stock items in bold type

## Features

- Suitable for HARTING SC contacts
- For GI-Fibre 50 - 62.5 / 125µm
- Using of guiding pins (male and female) is recommended (see chapter 40).

## Technical characteristics

Approvals



### Inserts

Number of contacts	4
Insertion loss	< 0.5 dB
Material	polycarbonate
Limiting temperatures	-40 °C ... +85 °C
Flammability acc. to UL 94	V 0
Mechanical working life	
- mating cycles	≥ 500

Han  
Modular

## Assembly instructions

### Male insert (09 14 004 4701)

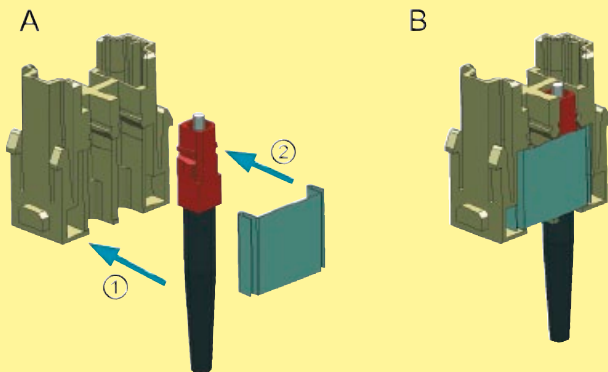

#### A Assemble the SC contact

Push the SC contact from the side into the relevant insert (1)  
Push the fixing plate from the side over the contacts (2)

#### B SC contact fixed in the module

### Female insert (09 14 004 4711)

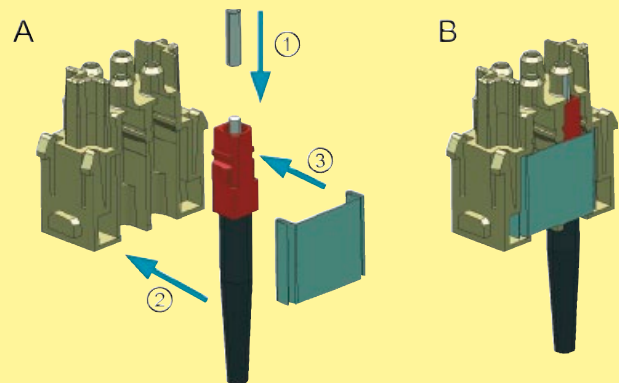

#### A Assemble the SC contact



Push the centering ferrule (included in delivery) on the SC contact (1)  
Push the SC contact from the side into the relevant insert (2)  
Push the fixing plate from the side over the contacts (3)

#### B SC contact fixed in the module

Number of contacts

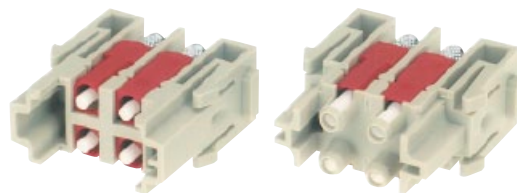
# 4

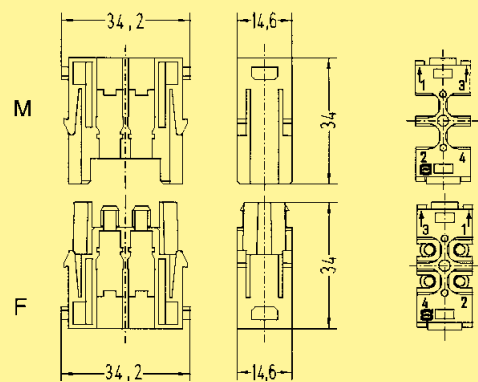

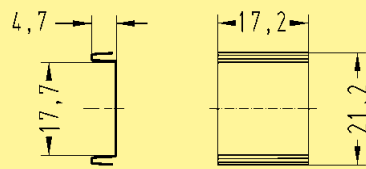
Identification	Part number		Drawing	Dimensions in mm
	Male insert (M)	Female insert (F)		
<p>SC module</p> <p>Order contacts separately</p> 	<b>09 14 004 4701</b>	<b>09 14 004 4711*</b>	 <p>M</p> <p>F</p> <p>Contact arrangement view from termination side</p>	
<p>Fixing plate</p> 	09 14 000 9965	09 14 000 9965		

Han Modular

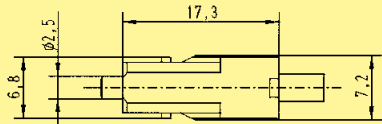
Identification	Part number		Drawing	Dimensions in mm
	Male contact	Female contact		
<p>SC contact</p> <p>for GI fibre 50/125 µm or 62.5/125 µm ceramic ferrule</p> 	<b>20 10 125 5211</b>	<b>20 10 125 5211</b>		
<p>for SI fibre (HCS®) 200/230 µm</p>	20 10 230 5211	20 10 230 5211		
<p>with quick assembly technique for 1 mm POF</p>	<b>20 10 001 5217</b>	<b>20 10 001 5217</b>		
<p>with crimp technique for 1 mm POF</p>	<b>20 10 001 5211</b>	<b>20 10 001 5211</b>		

\* The female inserts are equipped with centering ferrules.  
4 ferrules are included in delivery range.

Stock items in bold type

## Features

- Signal pre-processing and conversion do fit into the connector
- Individual combination of input and output modules for optimal signal pre-processing
- Minimum size for integration in Han® industrial connectors (Han-Modular® and Han-Snap®)
- Economy of space by reduction the number of terminal blocks and interface modules in the switch cabinet

## Technical characteristics

### Power supply

(combination input and output module)

Supply voltage	24 V (-10 % ... +25 %)
Current consumption	< 0.08 A
Power consumption	< 2 W
Total transmission error	< 0.2 %

Han  
Modular

## General description

The Han-Elisa® modules are a flexible I/O system - directly in the connector.

The input and output modules are developed for 1 or 2 channels and can be combined variously and flexible for optimal signal pre-processing. Within the product family modules are available for current/voltage conversion, temperature, relay and timer.

Due to the minimized size these modules can be integrated into the Han-Modular® and Han-Snap® system.

Signal pre-processing and conversion do fit into the connector and this will reduce installation space for terminal blocks and the number of interface modules. So the switch cabinets can be made smaller.

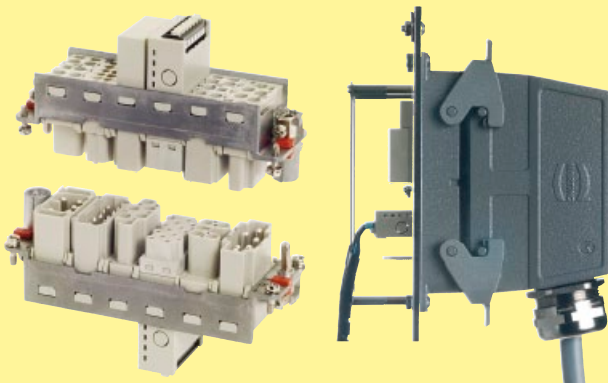

## Product matrix and possible combinations

input module (male)	output module (female)	Relay Different versions	Optocoupler Different versions	Output current 4 ... 20 mA galvanically isolated	Output voltage 0 ... 10 V galvanically isolated
Timing		○	○		
Connecting 1:1		○	○		
Temperature Pt100 Different temperature ranges				●	●
Temperature thermo element type J, K Different temperature ranges				○	○
Input current 4 ... 20 mA				○	○
Input voltage 0 ... 10 V				○	○

○ = on request  
● = available

## Features

- Minimum size for integration in Han® industrial connectors (Han-Modular® and Han-Snap®)
- Economy of space by reduction the number of terminal blocks and interface modules in the switch cabinet
- Male module for signal input

## Technical characteristics

### Inserts

Sensor	Pt100 acc. to IEC 751
Termination technology	2-, 3-, 4 wire technology
Sensor input current	0.8 mA, constant
Conductor resistance, max. permissible	10 Ω per conductor
Min. measuring range	100 °C
Open circuit detection	integrated

Material	polycarbonate / LCP
Termination	Cage-clamp terminal
- mm <sup>2</sup>	0.14 ... 1.5 mm <sup>2</sup>
- AWG	26 ... 16

Power diagnostic	LED (green)
------------------	-------------

### Temperature range

Working temperature	-20 °C ... +65 °C
Stock temperature	-40 °C ... +85 °C



## Pt100 Input module

Identification		Part number Male insert (M)	Drawing	Dimensions in mm
Temperature module Pt100				
Measuring range	0 ... 100 °C	<b>20 75 108 1101</b>		
	0 ... 200 °C	<b>20 75 108 1103</b>		
Additional measuring ranges on request				

Han  
Modular

## Features

- Minimum size for integration in Han<sup>®</sup> industrial connectors (Han-Modular<sup>®</sup> and Han-Snap<sup>®</sup>)
- Economy of space by reduction the number of terminal blocks and interface modules in the switch cabinet
- Female module for signal output

## Technical characteristics

### Inserts

Supply voltage	24 V (-10 % ... +25 %)
Load $I_{out}$	< 500 $\Omega$
Load $U_{out}$	$\geq$ 10 k $\Omega$
Residual ripple	< 20 mV (500 $\Omega$ )
Step response (0 ... 99 %)	< 30 ms

Material	polycarbonate / LCP
Termination	Cage-clamp terminal
- mm <sup>2</sup>	0.14 ... 1.5 mm <sup>2</sup>
- AWG	26 ... 16

Power diagnostic	LED (green)
------------------	-------------

### Temperature range

Working temperature	-20 °C ... +65 °C
Stock temperature	-40 °C ... +125 °C



## Output module

Identification	Part number Female insert (F)	Drawing	Dimensions in mm
<p>Output module, current 3-ways-isolating amplifier; galvanically isolated</p> <p>Output signal <span style="float: right;">4 ... 20 mA</span></p> <p>Additional output signal ranges on request</p>	<p><b>20 75 104 2201</b></p>	<p style="text-align: center;">Output</p>	
<p>Output module, voltage 3-ways-isolating amplifier; galvanically isolated</p> <p>Output signal <span style="float: right;">0 ... 10 V</span></p> <p>Additional output signal ranges on request</p>	<p><b>20 75 105 2201</b></p>	<p style="text-align: center;">Output</p>	

## Features

- Coding of tools possible (e.g. press tools) by means of an alphanumeric identification
- I<sup>2</sup>C bus EEPROM as memory medium
- Communication with PLC via conventional digital I/Os
- Physical connection of PLC by means of well-proven Han® contacts
- Assembly of the ID module to the device by means of a Han® industrial connector

## Technical characteristics

### Inserts

Supply voltage	24 V
Electrical connector, 24 V	via digital I/O device Han E® module (see page 06.42)
Memory capacity	max. 128 Byte
Material	polycarbonate
Working temperature	0 °C ... +70 °C
Stock temperature	0 °C ... +85 °C
Max. length recommended between I/O device and ID module	100 m *

Han  
Modular

## General description

The HARTING connector identification module (ID module) is suitable for storing of data and for coding of connectors. It is integrated in a Han-Modular® standard E module.

The module can be connected to a 24 V digital I/O device of a PLC. Two digital inputs are used for detecting the module connection and the data input. Two digital outputs are used for the data output and the system clock. Furthermore the ID module must be connected with 24 V and GND. Communication is carried out with voltage levels of 24 V according to the I<sup>2</sup>C bus standard. The total memory capacity is 128 Byte, e.g. for storing part numbers to identify the module. It is also possible to store the start parameters or operating data for machine components.

A typical data structure is displayed in the following table:

Byte no.

16	15	14	13	12	11	10	9	8	7	6	5	4	3	2	1
Check sum		Operating hours of tool				Start parameter of the unit				Part number of the unit					

Applications for the ID module can be found in modular machines and product lines. A great advantage of the ID module is the non volatile decentralized storing of e.g. operating data. When changing the location stored data can protect the machines from damages. In service cases of the equipment data can be analyzed to minimize service time.



## Input module

Identification	Part number Male insert (M)	Drawing	Dimensions in mm
Electronic identification module	<b>20 70 001 1001</b>		





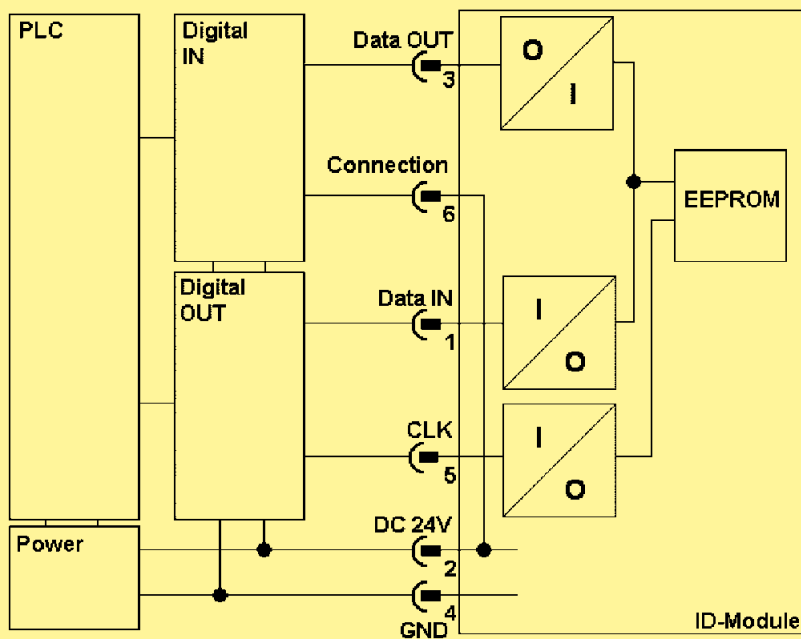

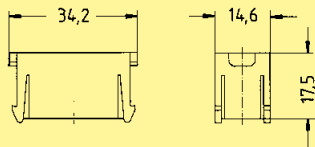

Han  
Modular

## Block diagram / Wiring plan

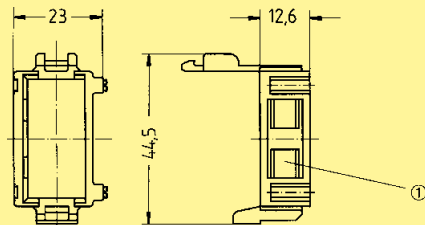

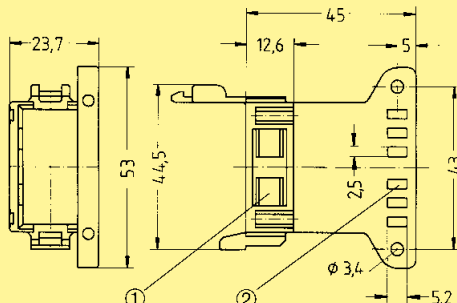
### Meaning of the connections

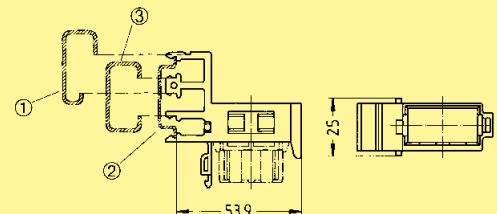
Pin no.	Name	Meaning/Function
1	Data IN	Input for data and control signals from PLC
2	DC 24 V	Power connection of the ID module
3	Data OUT	Output for data signals from ID module to PLC
4	GND	Ground
5	CLK	System clock for synchronisation
6	Connection	Output of the ID module for connection detection

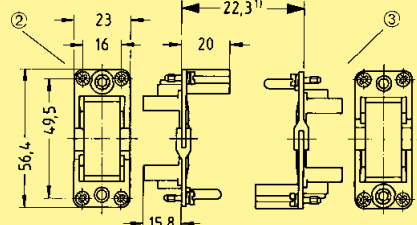
Identification	Part number	Drawing	Dimensions in mm
<p>Han-Modular® Dummy module to fill up module spaces not in use in the frame</p> 	<p><b>09 14 000 9950</b></p>		
<p>Module clamp without strain relief *</p>  <p>Delivery comprises one module clamp.</p>	<p><b>09 14 000 0311</b></p>	 <p>1 Slot for identification strip</p>	
<p>Module clamp with strain relief *</p>  <p>Delivery comprises one module clamp.</p>	<p><b>09 14 000 0312</b></p>	 <p>1 Slot for identification strip 2 For cable ties with max. 5 mm width</p>	
<p>Module clamp for rail *</p>  <p>Delivery comprises one module clamp.</p>	<p><b>09 14 000 0313</b></p>	 <p>1 G-rail DIN EN 60 715-G32 2 rail DIN EN 60 715-35 x 7.5 with 1 mm thickness or -35 x 15 with 1.5 mm thickness 3 C-rail DIN EN 60 715-C30</p>	
<p>Frame for 1 module</p>  <p>in housing Han® 10 A</p>	<p><b>09 14 000 0304</b></p>	 <p>1 Distance max. 23.5 mm 2 Hoods 3 Housings</p>	

\* Suitable for the single modules Han® C Crimp, Han® C Axial, Han E® Crimp, Han EE®, Han E® Protected, Han DD® Crimp, Han® High Density, Han® USB, Han® Firewire, Han® Multi module and Han® SC